

KDC-9020R/MP919 /PSW9521/X759

SERVICE MANUAL

The CD mechanism information is not in this service manual.

Please, refer to service manual. KDC-9020R/PSW9521 : X92-4470-0x(B51-7899-00)
KDC-MP919 : X92-4460-00(B51-7891-00)
KDC-X759 : X92-4450-00(B51-7889-00)

KDC-X759

Panel assy
(A64-2568-02)

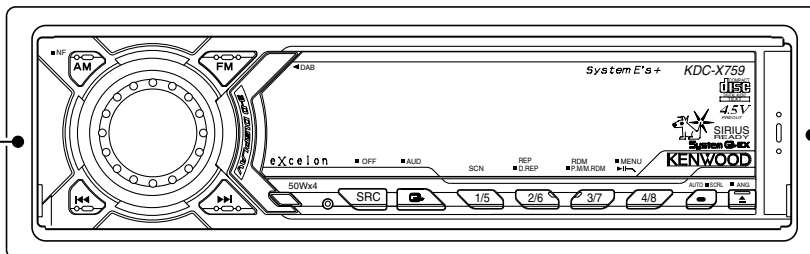

Escutcheon assy
(B07-3007-03)

KDC-MP919

Panel assy
(A64-2569-02)

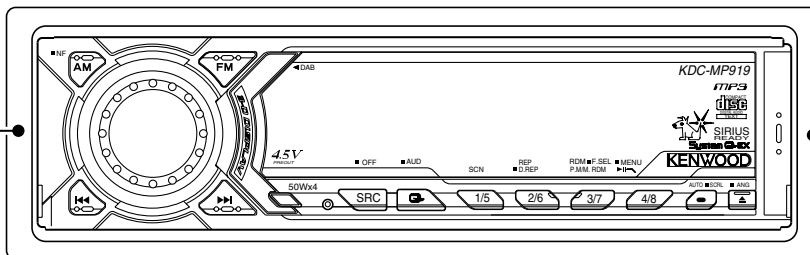

Escutcheon assy
(B07-3007-03)

KDC-9020R KDC-PSW9521

Panel assy
KDC-9020R:
(A64-2570-02)
KDC-PSW9521:
(A64-2586-02)

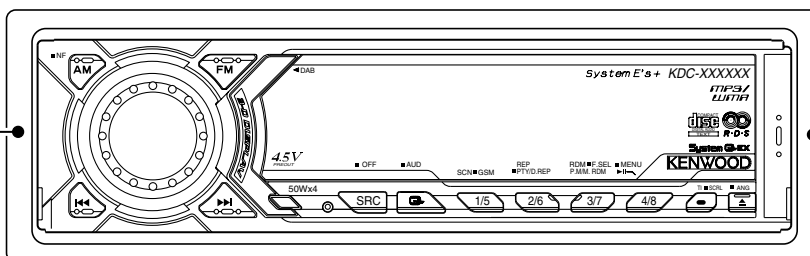

Escutcheon assy
(B07-3007-03)

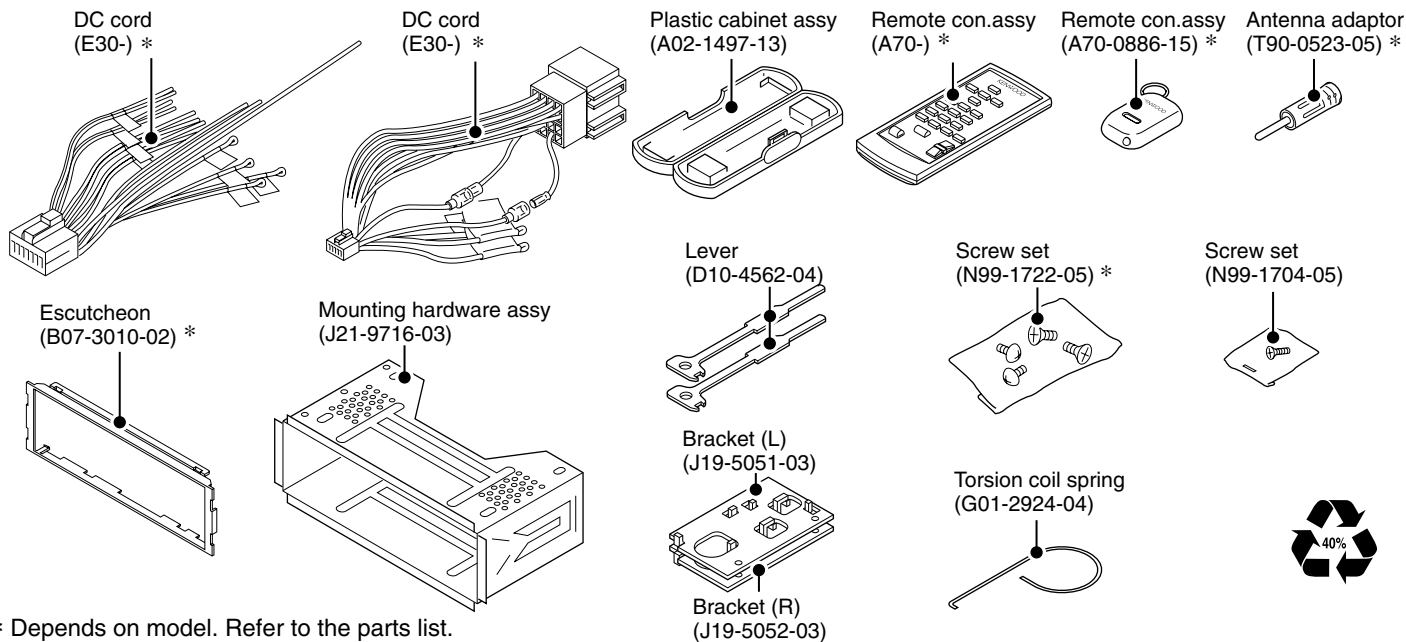

* Depends on model. Refer to the parts list.



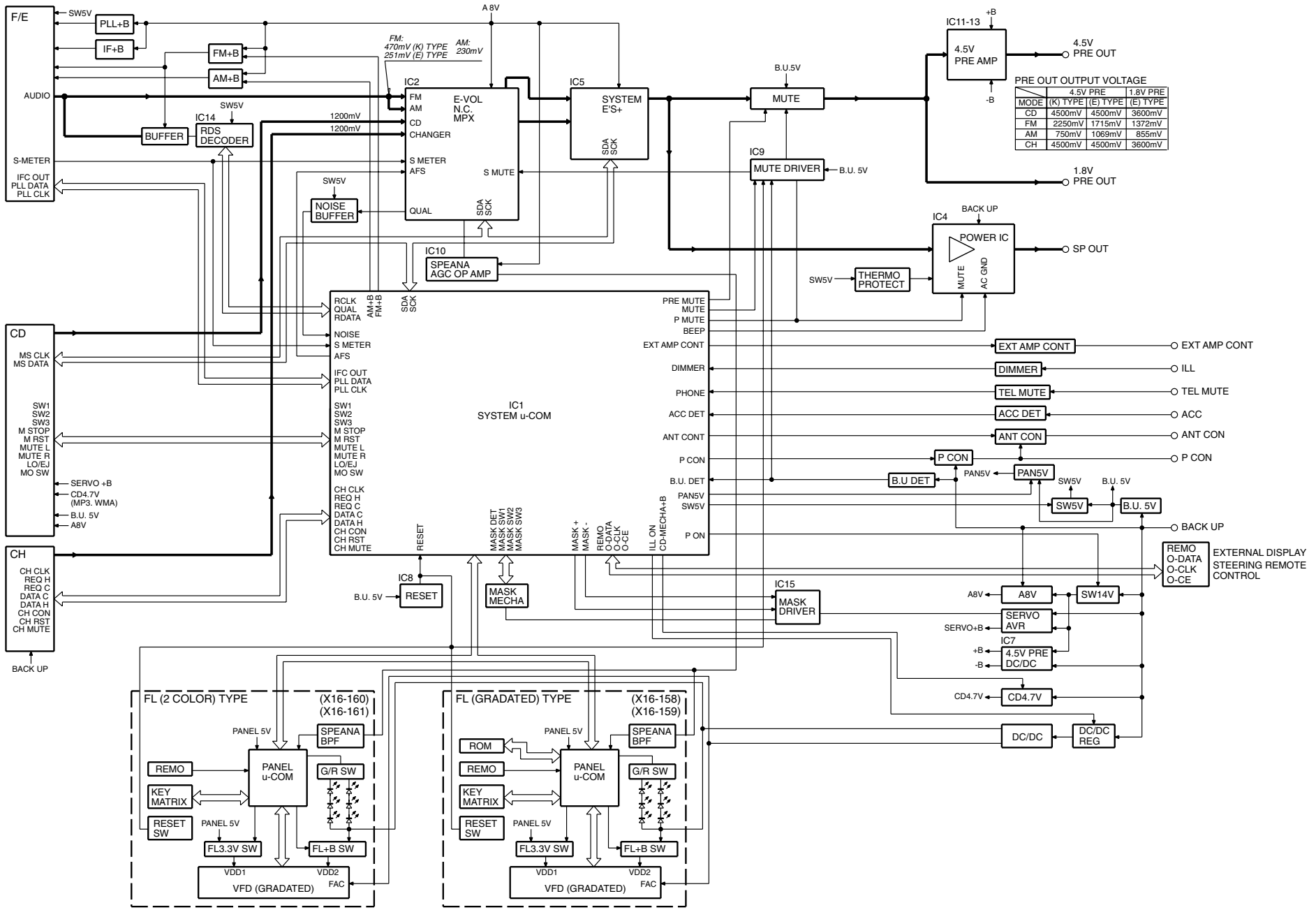

BLOCK DIAGRAM

KDC-9020R/MP919/PSW9521/X759

COMPONENT DESCRIPTION

ELECTRIC UNIT (X25-91xx-xx)

Element	Purpose & Function	Operation, Condition, Compatibility
IC1	System uCOM	
IC2	E.Vol & N.C. MPX	
IC3	Power Supply IC	Error detection in combination with Q8. Audio 8 V AVR drive.
IC4	POWER IC	50Wx4ch
IC5	HPF & LPF & NON-FAD SW	
IC6	CD mechanism 4.7 V power SW-Reg.	
IC7	4.5 V PRE-OUT DC/DC	
IC8	RESET IC	"L" when Mask uCOM detection voltage is 3.7 V or less or when Flash uCOM detection voltage is 4.2 V or less.
IC9	Muting logic IC	4 inputs. NOR gate x 4.
IC10	Spectrum analyzer opamp	
IC11	4.5 V PRE-OUT opamp	Front output.
IC12	4.5 V PRE-OUT opamp	Rear output
IC13	4.5 V PRE-OUT opamp	Non-Fad. output
IC14	RDS decoder	
IC15	Motor Dr. IC	For storage mechanism
IC16	E2PROM	
Q1,2	BU 5V AVR	Darlington connected.
Q3	SW 5V	ON when the base is "L".
Q4,5	SW 14V	Turns Q7 ON when the base of Q5 is "H".
Q6,7	AUDIO 8V AVR ON/OFF SW	8 V ON/OFF SW. Q7 turns ON when the base of Q6 is "H".
Q8	AUDIO 8V AVR	
Q9	Servo power AVR	
Q10	CD 4.7V SW-Reg ON/OFF SW	CD 4.7 V SW-Reg ON/OFF SW. ON when the base is "H".
Q11,12	FL & ILLUM AVR ON/OFF SW	FL & ILLUM AVR ON/OFF SW. Q12 turns ON when the base of Q11 is "H".
Q13,14	FL & ILLUM AVR ON/OFF SW	
Q15,16	4.5 V PRE-OUT DC/DC converter AVR	Darlington connected.
Q17~22	Regulated power supply Tr.	
Q23,24	POWER-ANT SW	Q24 turns ON when the base of Q23 is "H".
Q25,28	POWER-CONT SW	Q25 turns ON when the base of Q28 is "H".
Q26,27	POWER-CONT circuit output protection	Upon detection of drop in the output voltage, these transistors turn Q25 OFF to protect the output. This prevents malfunction of Q26 when the POWER-CONT SW turns ON.
Q29	External amp control SW	Turns ON when a pulse is input to the base.
Q30	Dimmer control SW	Small In is detected when the base is "H".
Q31	B-U detection	"L" when B-U is present. "H" when B-U is absent or momentary power down is detected."
Q32	Acc detection	"L" when Acc is present.
Q33	Lch MUTE Dr	L-ch audio muting SW drive. ON when the base is "L".
Q34	Rch MUTE Dr	R-ch audio muting SW drive. ON when the base is "L".
Q35	Spectrum analyzer AGC Tr.	
Q36	E-Vol muting SW	When the base is "L", turns ON to mute E-Vol.
Q37	Noise buffer	
Q38	AUDIO MUTE SW	Mutes the Front R CH hen the base is "H".
Q39	AUDIO MUTE SW	Mutes the Front L CH hen the base is "H".
Q40	AUDIO MUTE SW	Mutes the Rear R CH hen the base is "H".
Q41	AUDIO MUTE SW	Mutes the Rear L CH hen the base is "H".
Q42	AUDIO MUTE SW	Mutes the Non-FAD R CH hen the base is "H".
Q43	AUDIO MUTE SW	Mutes the Non-FAD L CH hen the base is "H".
Q45,46	FM+B SW	Q46 turns ON when the base of Q45 is "H".
Q47,48	AM+B SW	Q48 turns ON when the base of Q47 is "H".
Q49	Composite signal buffer	
Q50	PANEL 5V SW	When the panel is attached, the base goes "L", turning the transistor ON to supply 5 V to the panel.

KDC-9020R/MP919/PSW9521/X759

COMPONENT DESCRIPTION

SWITCH UNIT (X16-15xx-xx)

Element	Purpose & Function	Operation, Condition, Compatibility
IC1	PANEL u-com	
IC2	SPECTRUM ANALYZER IC	
IC3	REMOTE CONTROL IC	
IC4	BUFFER IC	It is changed into 3.3V from 5V
IC5	3.3V REGULATER	The power supply of IC and UFD(Logic) which are driver by 3.3V
IC6	ROM	
Q1	REMO ON SW	The power supply of IC2 and IC3 is turned on when the base level goes "L".
Q2	SC-CON SW	ON when the base level goes "H".
Q3,4	FL+B SW	FL+B(VDD2) is turned on when Q3's base level goes "H".
Q5	FL BLK SW	ON when the base level goes "H".
Q6,7	KEY ILLUMINATION SW	Lights green key-illumination when Q6's base level goes "H". Lights red key -illumination when Q7's base level goes "H".

MICROCOMPUTER'S TERMINAL DESCRIPTION

PANEL MICROCOMPUTER UPD703033GC150 (X16)

Pin	Name	I/O	Processing Operation
1	DATA1	O	Data communication with FL driver.
2	CLK	O	Clock communication with FL driver (rise data shifting)
3	NC	O	
4	DATA2	O	Data communication with FL driver.
5	CLK IN	I	CS12 serial clock input (for synchronizing Data 1 and 2).
6	EVDD	-	PAN.5V
7	EVSS	-	GND
8	RED LED	O	ILLUM Red switching. "H": ON. "L": OFF.
9	GREEN LED	O	ILLUM Green switching. "H": ON. "L": OFF.
10	REMO	I	Input from Remote Control IC.
11	LATCH	O	Latch for FL driver.
12	GCP	O	Brightness graduation control.
13	REMO ON	I/O	Remote Control IC power ON/OFF. "HI-Z": OFF. "L": ON.
14-16	A13-15	O	ADDRESS
17	BLK	O	Display for FL driver. Blanking display. "L": Display OFF. "H": Display ON.
18	TEST	I	INTEMALLY CONNECTED
19-30	A1-12	O	ADDRESS
31	RESET	I	RESET
32	XT1	-	GND
33	XT2	O	
34	REGC	-	Regulator capacitance connection
35	X2	-	MAIN CLOCK
36	X1	-	MAIN CLOCK
37	VSS	-	GND
38	VDD	-	PAN.5V
39-42	NC	O	
43	OE	I/O	Output Enable. "L": Data sending. "Hi-Z": Standby.
44	CE	I/O	Chip Enable. "L": Data sending. "Hi-Z": Standby
45	FL+3.3V	O	FL+3.3V ON/OFF "H":ON "L":OFF
46	FL+B	I/O	FL+B ON/OFF "H":ON "HiZ":OFF
47-54	AD0-7	I	DATA for external ROM.
55	BVDD	-	PAN.5V
56	BVSS	-	GND
57-64	AD8-15	I	DATA for external ROM.
65-68	A16-19	O	ADDRESS
69	NC	O	
70	A20	O	ADDRESS
71	AVDD	-	PAN.5V
72	AVSS	-	GND
73	AVREF	-	
74	F01	I	BPF(63Hz)
75	F02	I	BPF(150Hz)
76	F03	I	BPF(330Hz)
77	F04	I	BPF(1kHz)
78	F05	I	BPF(3.3kHz)
79	F06	I	BPF(10kHz)
80	WAVE IN	I	Voice input.
81	KR3	I	KEY RETURN
82	KR2	I	KEY RETURN
83	KR1	I	KEY RETURN
84	VOL B	I	VOL input.
85	VOL A	I	VOL input.
86	SC REQ	O	Request communication with System Controller. "H": Requested.
87	NC(FAC IN)	O	(Flicker prevention circuit input)

KDC-9020R/MP919/PSW9521/X759

MICROCOMPUTER'S TERMINAL DESCRIPTION

PANEL MICROCOMPUTER UPD703033GC150 (X16)

Pin	Name	I/O	Processing Operation
88	SC CON	I	Panel uCOM control. During operation: "L".
89	OPEN KEY	I	OPEN KEY "H":ON "L":OFF
90	SOURCE KEY	I	SOURCE KEY "H":ON "L":OFF
91	VREF CON	O	VREF CONTROL During operation:H
92	MC REQ	I	Request input from System Controller. "H": Requested.
93	KS4	I/O	KEY SCAN(Hi-Z/L)
94	KS3	I/O	KEY SCAN(Hi-Z/L) Flash uCOM write port. (DI)
95	KS2	I/O	KEY SCAN(Hi-Z/L) Flash uCOM write port. (DO)
96	KS1	I/O	KEY SCAN(Hi-Z/L) Flash uCOM write port.(CLK)
97	MC DATA	I	Data communication with System Controller.
98	SC DATA	I/O	Data communication with System Controller.
99	MC CLK	I	Clock input from System Controller
100	NC	O	

MICROCOMPUTER'S TERMINAL DESCRIPTION

SYSTEM MICROCOMPUTER uPD703033AGF-***-3BA (X25)

Pin	Name	I/O	Purpose	Processing Operation	Processing During Non-Operation	Processing During STBY
1	MC-DATA	I/O	DATA line to Panel uCOM.		Hi-Z	Hi-Z
2	MC-CLK	O	CLK line to Panel uCOM.		Panel attached: "H". Detached: "Hi-Z".	H
3	PLL-DATA	I/O	DATA I/O to/from F/E.		Hi-Z	Hi-Z
4	PLL-CLK	I/O	CLK I/O to/from F/E.		Hi-Z	Hi-Z
5	AM+B	I/O	AM power supply terminal.	During AM operation: "H".	Hi-Z	Hi-Z
6	FM+B	I/O	FM power supply terminal.	During FM operation: "H". With RDS and RBDS only, last FM: "H".	Hi-Z	Hi-Z
7	CH-CON	O	CH control output.	ON: H OFF: L	L	L
8	CH-RST	O	CH reset output.	Normally "H". In recovery after system RST, remains H for 400 ms then goes L"	L	L
9	Evdd	-	Positive power supply terminal.			
10	Evss	-	GND terminal.			
11	AFS	O	Time constant switching upon noise detection.	During FM seek and AM search: L. During reception; H.	Last FM with RDS and RBDS: "H". Without RDS and RBDS: "L".	L
12	BEEP	O	Beep output terminal.		L	L
13	REMO	I	Wired remote input terminal.	Since there is no wired remote control, connected to GND.		
14	N.C	O	Output Open. Not used.			L
15	N.C	O	Output Open. Not used.			L
16	IC2-SDA	I/O	IC2, IC5 and CD mechanism DATA line.		Hi-Z	Hi-Z
17	IC2-SCL	I/O	IC2, IC5 and CD mechanism CLOCK line.		Hi-Z	Hi-Z
18	PRE-MUTE R	O	PREOUT(Rch)MUTE	"L" when M MUTE R is L (during CD playback). "L" during momentary power down. "H" only in 2-zone operation.	"H" (other sources than CD)	H
19	PRE-MUTE L	O	PREOUT(Lch)MUTE	"L" when M MUTE R is L (during CD playback). "L" during momentary power down. "H" only in 2-zone operation.	H (other sources than CD)	H
20	N.C	O	Output Open. Not used.	L		
21	TEST	-	Test pin.	Normal: "L". During		
22	N.C(SVR)	O		power OFF: "H" in 5 sec. Power OFF: H		"H" ("L" in 5 sec. after Power OFF).
23	P-MUTE	O	Power IC MUTE terminal.	Power OFF: L All OFF: "L". Tel muting: "L"	H	"L" ("H" in 5 sec. after P-ON OFF).
24	P-STBY	O	Power IC STBY terminal.	POWER IC ON: H POWER IC OFF : L ALL OFF: H	L	L
25	MUTE	O	Muting terminal.	ON: Open. OFF: "L". Time constant: 0.48 ms (with both ON/OFF)	L	Open ("H" in 5 sec. after P-ON OFF).

MICROCOMPUTER'S TERMINAL DESCRIPTION

SYSTEM MICROCOMPUTER uPD703033AGF-***-3BA (X25)

Pin	Name	I/O	Purpose	Processing Operation	Processing During Non-Operation	Processing During STBY
26	SW5V	I/O	5V power supply terminal.	ON: L OFF: Hi-Z	Hi-Z	"L ("Hi-Z" in 10 sec. after Power OFF).
27	BU-DET	I	Momentary power down detection terminal.	B-U present: "L". B-U absent (momentary power down): "H".		
28	ACC-DET	I	Acc detection terminal.	Acc present: "L". Acc absent: "H".		
29	N.C	O	Output Open. Not used.			L
30	DIMMER	I	Small detection terminal.	ON: L OFF: H		
31	EXT-AMP-CONT	O	External amp control terminal (200 ms).	"L for 40 ms: Bass Boost Off. "L" for 70 ms: Bass Boost Low. "L" for 100 ms: Bass Boost High.	H	H
32	P-CON	I/O	Power control terminal.	POWER ON: H POWER OFF: Hi-Z ALL OFF: Hi-Z	Hi-Z	Hi-Z
33	ANT-CON	O	Antenna control terminal.	TUNER, TI ON: H Other sources in last FM with RDS: "H". Other sources in last FM with RBDS, TI ON: "H".	L	L
34	RESET	I	Reset input terminal.	Normal: "H". Reset: "L".		
35	XT1	I	Sub-clock connection terminal.	Clock count. Working while power is OFF.		
36	XT2	-	Sub-clock connection terminal.			
37	REGC	-	Output terminal for capacitor of Reg. in uCOM.			
38	X2	-	Main clock connection terminal.	During power ON: Oscillating. During power OFF and momentary power down: Oscillation stopped.		
39	X1	I	Main clock connection terminal.			
40	Vss	-	GND terminal.			
41	Vdd	-	Positive power supply terminal.			
42	CLKOUT	O	Internal system clock terminal.			
43	CD MECHA+B	I/O	CD 4.7 V output terminal.	With CD source: "L". Other sources than CD: "Hi-Z". Models without MP3 or WMA: Output "L". ON: 50 ms faster than M-STOP. OFF: 50 ms slower.	Hi-Z	Hi-Z
44	P-ON	I/O	SW 14 V control terminal.	POWER ON: H POWER OFF: Hi-Z	Hi-Z	"H ("Hi-Z" in 10 sec. after power OFF).
45	O-DATA	I/O	External display DATA terminal.	Models without external display: Output "L".	L	L

MICROCOMPUTER'S TERMINAL DESCRIPTION

SYSTEM MICROCOMPUTER uPD703033AGF-***-3BA (X25)

Pin	Name	I/O	Purpose	Processing Operation	Processing During Non-Operation	Processing During STBY
46	O-CLK	I/O	External display CLK terminal.	Models without external display: Output "L".	L	L
47	O-CE	I/O	External display CE terminal.	Models without external display: Output "L".	L	L
48	ILL-ON	I/O	FL and ILLUM output terminal.	ON: H OFF: Hi-Z	Hi-Z	Hi-Z
49	TYPE0	I	Destination type switching port.			
50	TYPE1	I	Destination type switching port.			
51	TYPE2	I	Destination type switching port.			
52	IC2TYPE0	I	IC2 destination type terminal.	Default: "L".		
53	IC2TYPE1	I	IC2 destination type terminal.	Default: "L".		
54	N.C	O	Output Open. Not used.			
55	N.C	O	Output Open. Not used.			
56	M-MUTE R	I	Muting request from CD mechanism. (R CH)	ON: L		
57	M-MUTE L	I	Muting request from CD mechanism. (L CH)	ON: L		
58	BVdd	-	Positive power supply terminal.			
59	BVss	-	GND terminal.			
60	M-RST	O	Reset output to CD mechanism.	Normal: "H". Reset: "L". According to the mechanism control specification.	H	H
61	M-STOP	O	Stop request to CD mechanism.	STOP: L CD: H	L	L
62	N.C	O	Output Open. Not used.			L
63	CD-SW3	I	CD Down SW detection terminal.	Chucking: "H".	L	
64	LO/EJ	I/O	CD mechanism Loading/Ejection switching.	Stop, braking: "Hi-Z". Loading: "L". Ejection: "H".	Hi-z	Hi-Z
65	MOSW	O	CD mechanism motor power supply SW.	Loading, ejection, braking: "H".	L	L
66	N.C	O	Output Open. Not used.			L
67	PAN-RESET	O	Reset output to Panel uCOM.	Normal: "H". Reset & momentary power down: "L".	Panel attached: "H". Panel detached: "L".	Panel attached: "H". Panel detached: "L".
68	MC-REQ/ PANEL	I/O	REQ terminal to Panel uCOM/Panel detection.	Panel attached: "L".	Hi-z	Hi-Z
69	N.C	O	Output Open. Not used.			L
70	PAN5V	I/O	Panel 5 V control terminal.	Panel attached: "L". Panel detached: "Hi-Z".		Panel attached: "L". Detached: "Hi-Z".
71	MASK+B	O	Mask mechanism sub-motor output terminal.		L	
72	MASK-B	O	Mask mechanism sub-motor output terminal.		L	
73	AVCONT	O	AD reference voltage control output.	Same timing as P-ON. During operation: "H"	L	L

MICROCOMPUTER'S TERMINAL DESCRIPTION

SYSTEM MICROCOMPUTER uPD703033AGF-***-3BA (X25)

Pin	Name	I/O	Purpose	Processing Operation	Processing During Non-Operation	Processing During STBY
74	Avdd	-	Positive power supply terminal.			
75	Avss	-	GND terminal.			
76	Avref	I	A/D converter reference voltage supply terminal.			
77	PHONE	I	Phone detection terminal.	TEL muting: 1 V or less NAVI muting: 2.5 V or more.		
78	E2PROMDET	I	E2PROM detection terminal.	E2PROM present: "H". E2PROM absent: "L".		
79	MASK-SW1	I	Mask mechanism position detection.	Refer to the 01MASK mechanism position detection chart		
80	MASK-SW2	I	Mask mechanism position detection.	Refer to the 01MASK mechanism position detection chart		
81	MASK-SW3	I	Mask mechanism position detection.	Refer to the 01MASK mechanism position detection chart		
82	MASK-DET	I	Mask mechanism detection.	Mechanism present: "L". Mechanism absent: "H".		
83	NOISE	I	FM noise detection terminal.			
84	S-METER	I	S-meter detection terminal.			
85	R-DATA	I	RDS decoder DATA input terminal.	Models without RDS and RBDS: Connected to GND.		
86	R-QUAL	I	RDS decoder OUAL input terminal.	Models without RDS and RBDS: Connected to GND.		
87	IFC-OUT	I	F/E IFC OUT input terminal.	Station detected: 2.5 V or more.		
88	CH-MUTE	I	Muting request from CH.			
89	CH-REQH	O	Request output to CH.	Request: "L".	H	H
90	R-CLK	I	RDS decoder CLK input terminal.	Models without RDS and RBDS: Connected to GND.		
91	CH-REQC	I	Request input from CH.	Requested: "L".		
92	SC-REQ	I	Communication request from Panel uCOM.			
93	CD-SW1	I	Loading SW detection terminal.	Loading start: "L". Take care that the logic in power OFF is different from Flip.		
94	CD-SW2	I	12 cm disc detection SW terminal.	12 cm disc: "L". Take care that the logic in power OFF is different from Flip.		
95	N.C	O	Output Open. Not used.			L
96	N.C	O	Output Open. Not used.			L
97	CH-DATAC	I	DATA input terminal from CH.			
98	CH-DATAH	O	DATA output terminal to CH.		Last state held.	L
99	CH-CLK	I/O	CLK input/terminal from/to CH.			Hi-Z
100	SC-DATA	I	DATA line from Panel uCOM.			Hi-Z

TEST MODE

Test Mode

1. How to enter test mode

While holding the [1/5] key and the [3/7] key, reset the unit.

2. How to exit from test mode.

While holding down the [4/8] key, reset the unit.

Note: Does not exit from test mode ACC OFF, Power OFF or momentary power down

3. Test mode reset status

- Sources are all OFF
- All display segment lit up
- Volume at -10dB (shows 30 on display)
- LOUD is OFF.
- CRSC is OFF regardless of whether switching function is provided.
- SYSTEM Q is in FLAT
- BEEP sounds at momentarily pressing at any time.

4. Special displays in Tuner

When the following displays appear in tuner mode it shows a problem with the front end.

- "TNE2P NG" : F/E is not aligned and EEPROM is in reset (no settings) such as when shipped.
- "TNCON NG" : Cannot communicate with F/E (front end).

5. K3I switching

Each time the Preset 6 key is pressed in Tuner mode, switches one at a time through the following sequence: AUTO → Forced Wide → Forced Middle → Forced Narrow → AUTO.

When reset, displays the following in AUTO.

- AUTO : FMA
- Forced Wide : FMW
- Forced Middle : FMM
- Forced Narrow : FMN

6. CD receiver test mode specifications

- No automatic ejection during reset-start. Does not make a CD check in reset with a CD loaded.
- Using the Track up key jumps to the following tracks. No. 9 → No. 15 → No. 10 → No. 11 → No. 12 → No. 13 → No. 14 → and back to No. 9
- Using the Track down key moves 1 track downwards from the track being played.
- When the total number of MP3 or WMA disc tracks is 9 or less, playback starts from the first track.
- With the model equipped with the MP3 or MP3/WMP mechanism, the mechanism model name and version number are displayed at the bottom line.

7. Audio items

- Momentarily pressing the Q key calls up audio adjustment mode.
- Pressing the * key on the remote control calls up audio alignment mode.
- An initial item is set to Feder.
- Continuous forward is disabled on the remote control.
- Bass/Middle/Treble/NF are settable in 3 steps of MIN / Center / MAX with the Track up/down keys.

- Balance is settable in 3 steps of Left MAX / Center / Right MAX with the Track up/down keys.
- Fader is settable in 3 steps of Rear MAX / Center / Front MAX with the Track up/down keys.
- HPF is settable in 2 steps of THRU/220Hz with the Track up/down keys.
- LPF is settable in 2 steps of THRU/120Hz with the Track up/down keys.
- Bass f / Bass Q / Bass EXT / Middle f / Middle Q / Treble f do not appear in the audio alignment.

8. Menu items

- The DNPP/SBF keys on the remote control calls up Menu mode.
- Continuous forward is disabled on the remote control.

9. Backup current measurement

The MUTE terminal turns off 2 seconds (not 15 seconds) after being reset in ACC off (backup on). (The panel and CD mechanisms are disabled during this time.)

10. Special displays during All-Off with all lamps on

The following displays appear when the preset keys are pressed with all display segment lit up.

[1/5]key	<ul style="list-style-type: none"> • Version display (8 digits; Mo. Dy. Hr. Mn.) (Display) SYS XXXXXXXX system microprocessor PAN XXXXXXXX panel microprocessor • Serial No. display (8 digits) (Display) SNo XXXXXXXX
[2/6]key	<ul style="list-style-type: none"> • Press once: Power on time display (Does not count during All-Off) Press long: Clears the time display during power-on. (Display) PonTim XXXXX MAX 65535(time) • Press once: CD operating time display. Press long: Clears CD operating time. (Display) CDTime XXXXX MAX 65535(time)
[3/7]key	<ul style="list-style-type: none"> • Press once: CD eject count display. Press long: Clears CD eject count display. (Display) EjeTim XXXXX MAX 65535(count)
[4/8]key	<ul style="list-style-type: none"> • Press once: PANEL open/shut count display. Press long: Clears PANEL open/shut count display. (Display) PnCnt XXXXX MAX 655350(count)

11. Channel space switching (K/M type)

While holding the [1/5] key and the [4/8] key, reset the unit.

12. Others

- Automatic panel close is disabled when CD is inserted.
- Panel operation is disabled at Power-ON or Power-OFF.
- Panel open and closes with press long the Q key.
- No displays such as "CODE OFF" during Power-ON.
- Pressing the TI (AUTO) key during changer operation turns on 2zone. Cancel by pressing the TI (AUTO) key again. The P/S dot is lit during 2zone.
- Pressing the [4/8] key for 1 second or more during All OFF, calls up the Mask Key (security) write mode.

TEST MODE

Security items

1. Forced power-ON mode (all models)

Even when writing is permitted by the security function (mask key), Power-on can be set for a 30 minute period each time the reset key is pressed while holding down the Q key and [4/8] keys. After 30 minutes elapses, can only be restored by using reset.
2. How to register the security code for EEPROM (F/E) replacement (coded security models)
 - (1) Enter the test mode. (See "1. How to enter the test mode")
 - (2) Press the [4/8] key to enter the MENU MODE.
 - (3) While "Security" is displayed, press and hold the Track up or down key for a second to enter the security registration mode.
 - (4) Enter the code using the FM/AM/Track up/Track down keys.

FM key: Increments the number.
AM key: Decrements the number.
Track up key: Moves the cursor to the right.
Track down key: Moves the cursor to the left.
 - (5) Hold down the Track up key for at least 3 seconds and the message, "RE-ENTER" appears, so once again enter the code according to Step 4 above.
 - (6) Hold down the Track up key for at least 3 seconds, and the message, "APPROVED" appears.
 - (7) Cancel test mode. (See, 2. How to cancel the test mode.)

Note: All clear cannot be performed on the security code for this model.
3. Simple way to clear the security code (K type only)
 - (1) During code request mode, press the Track Up key for at least 3 seconds while holding down the AUTO key. (---- will disappear)
 - (2) Enter, "KCAR" with the remote controller as described below. (Same as on 01 model.)
 - Press the remote controller 5 key twice, and press the Track Up key. (Enters a "K")
 - Press the remote controller 2 key three times, and press the Track Up key. (Enters a "C")
 - Press the remote controller 2 key once, and press the Track Up key. (Enters an "A")
 - Press the remote controller 7 key twice, and press the Track Up key. (Enters an "R")
 - (3) Security function is canceled and unit sets to All-Off mode.
 - (4) Code request mode appears if a mistake was made in entering the numbers.
4. Method of writing the Mask key while the EEPROM is in the initial status
 - (1) Enter the test mode. (See "1. How to enter the test mode")
 - (2) Press the [4/8] key to enter the Mask key registration mode. "TRANSMIT1" should be displayed now. The display at this time should show "< >" in place of "[]".
 - (3) Point the Mask key remote toward the light sensor, and press and hold its key for more than 0.5 second.
 - (4) When "TRANSMIT2" is displayed, press and hold the key on the Mask key remote for more than 0.5 second again. The first and second counter codes are not compared at this time.
 - (5) When "APPROVED" is displayed, the write operation is complete. Now the demonstration mode is initiated and the test mode is terminated.

(Note) In the same way as previous models, if 30 minutes have elapsed with no code written, an error occurs and the power is turned OFF.
5. Method of initializing the Mask key (How to reset the unit from the Mask key approved condition to the factory condition)
 - (1) Enter the test mode. (See "1. How to enter the test mode")
 - (2) "TRANSMIT1" is displayed and the Mask key entry request mode is initiated. The display at this time should show "* *" in place of "[]".
 - (3) Press and hold the key on the Master key remote for more than 3 seconds.
 - (4) When "TRANSMIT2" is displayed, press and hold the key on the Master key remote for more than 3 seconds again.
 - (5) When "APPROVED" is displayed, the Mask key is cleared, the demonstration mode is initiated, the test mode is terminated and the unit returns to the factory condition.
6. Method of clearing all Mask key-related data
 - (1) Enter the test mode. (See "1. How to enter the test mode")
 - (2) Press the [4/8] key to enter the Mask key registration mode. "TRANSMIT1" should be displayed now.
 - (3) Point the Master key remote toward the light sensor, and press and hold its key for more than 3 seconds (until the level display shows the full condition).
 - (4) When "TRANSMIT2" is displayed, hold the key on the Mask key remote for more than 3 seconds again. If "TRANSMIT1" is displayed in place of "TRANSMIT2", restart the procedure from step 3.
 - (5) When "APPROVED" is displayed, all security data is cleared and the unit returns to the condition before Mask key writing with the EEPROM in the initial status

PC BOARD(Component side view)

X16-1580-10/1592-70 (J74-1310-12)

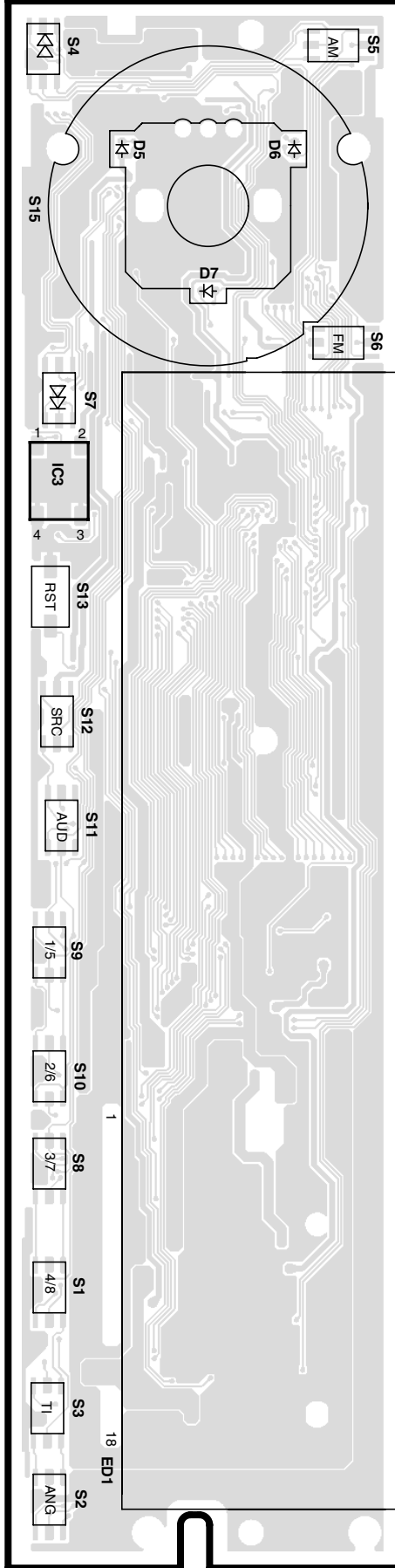

X16-1580-10/1592-70

Ref.No	Address
IC3	3A

X25-9170-10/9182-70

Ref.No	IC1	IC2	IC3	IC4	IC5	IC6	IC7	IC9	IC10	IC11	IC12	IC13	IC14	IC15	Q1	Q2	Q3	Q4	Q5	Q6	Q7	Q8
Address	3G	4E	5I	6E	4F	2I	3H	4F	3E	4G	4G	5G	3E	2E	4I	4I	4G	5I	5I	5I	5I	5J

Ref.No	Q9	Q11	Q12	Q13	Q15	Q16	Q23	Q24	Q25	Q28	Q29	Q30	Q31	Q32	Q38	Q39	Q40	Q41	Q42	Q43	Q46	Q48
Address	2D	5I	5I	5I	3I	3I	5H	6I	5G	5G	5H	4H	4H	4H	4G	4G	4G	4G	5G	5G	4D	4D

X25-9170-10/9182-70 (J74-1309-12)

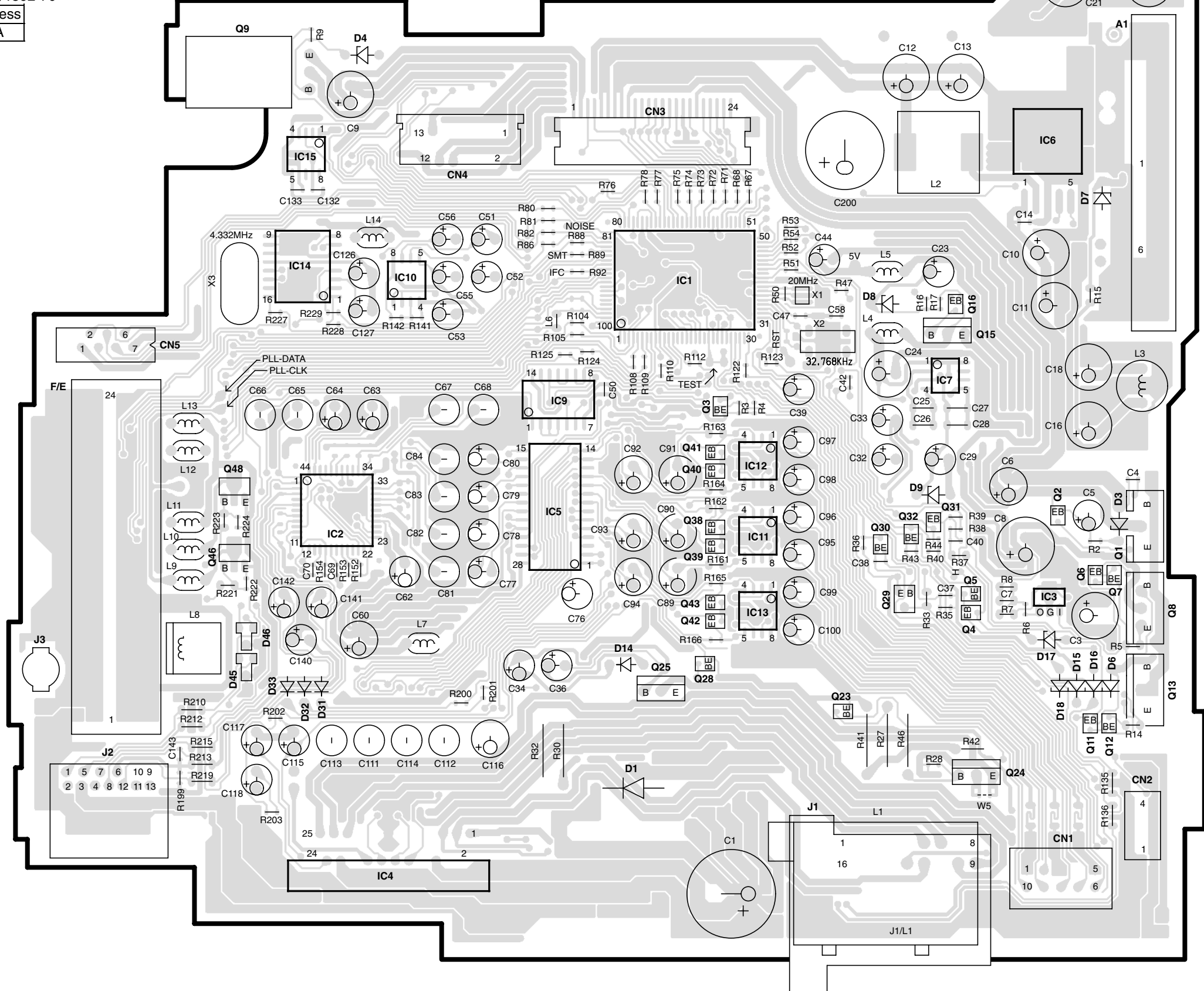

PC BOARD(Foil side view)

X25-9170-10/9182-70

Ref.No	IC8	IC16	Q10	Q14	Q17	Q18	Q19	Q20	Q21	Q22	Q26	Q27	Q33	Q34	Q35	Q36	Q37	Q45	Q47	Q49	Q50
Address	2P	3Q	3N	5N	4O	3O	3O	4N	4O	4O	5Q	6Q	4P	4P	3Q	4R	4R	5S	4S	3R	2R

X16-1580-10/1592-70 (J74-1310-12)

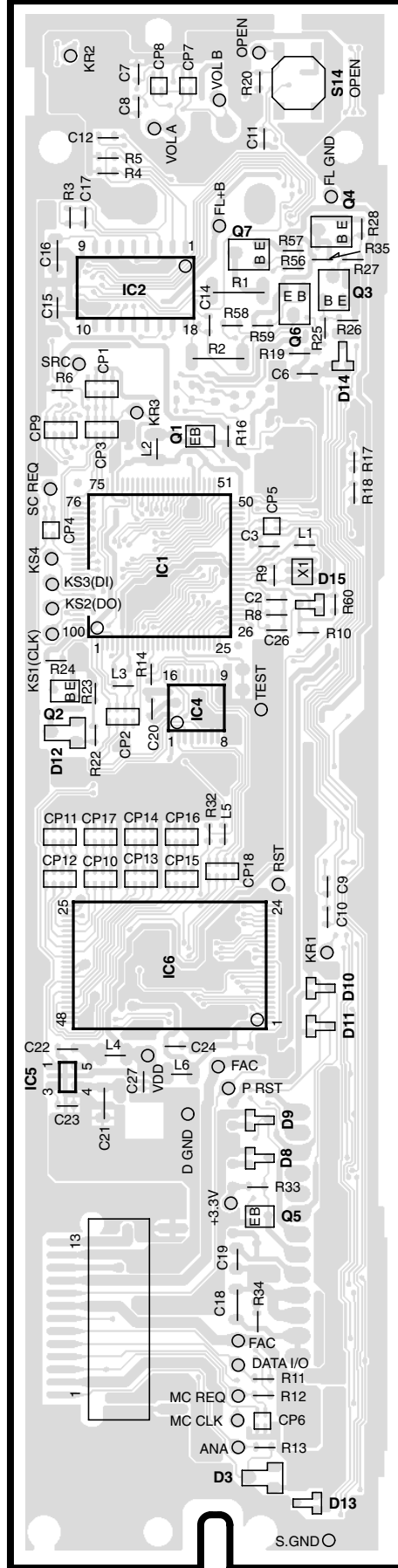

X16-1580-10/1592-70

Ref.No	Address
IC1	3L
IC2	2K
IC4	4L
IC5	5K
IC6	5L
Q1	3L
Q2	4K
Q3	2L
Q4	2L
Q5	6L
Q6	2L
Q7	2L

X25-9170-10/9182-70 (J74-1309-12)

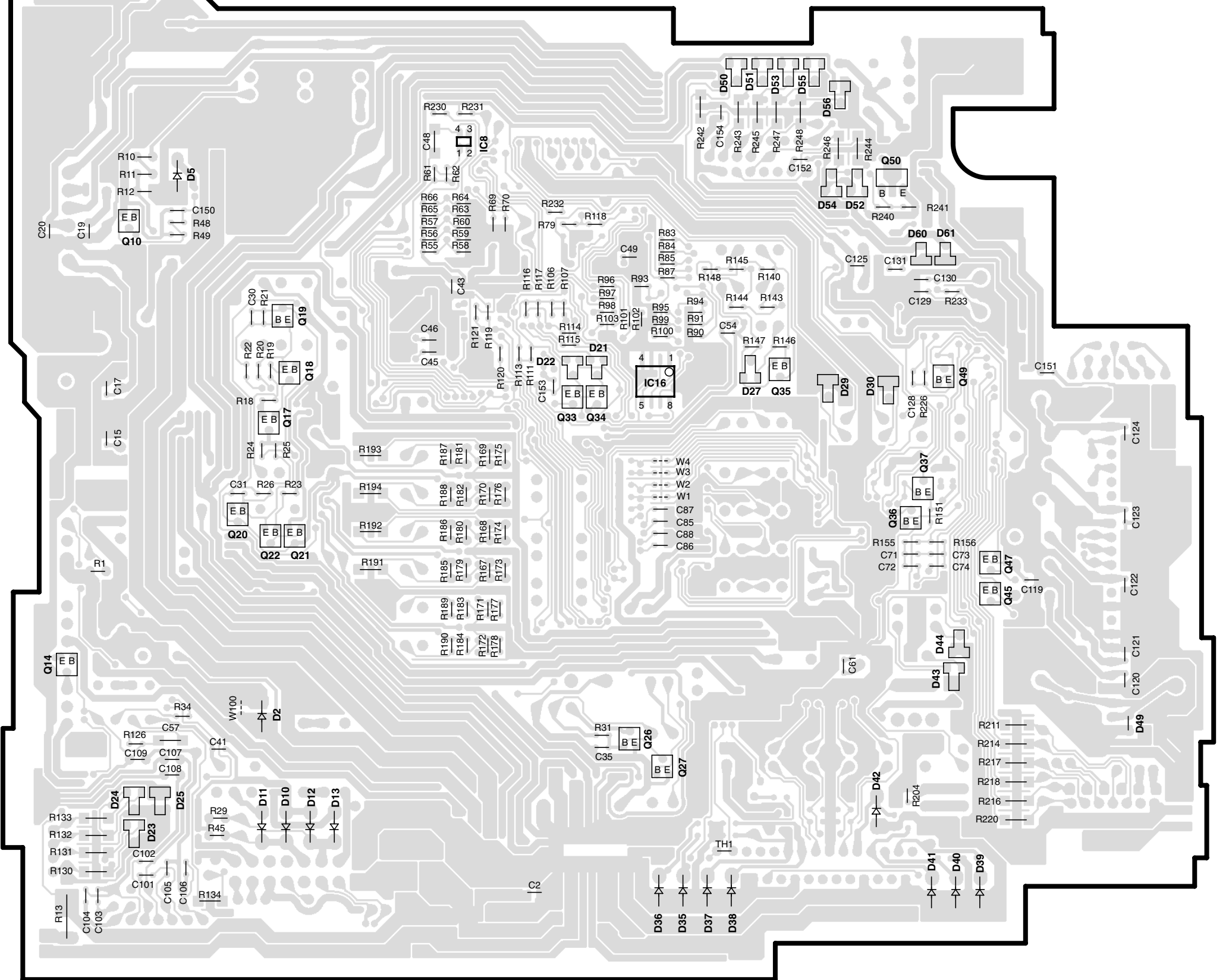

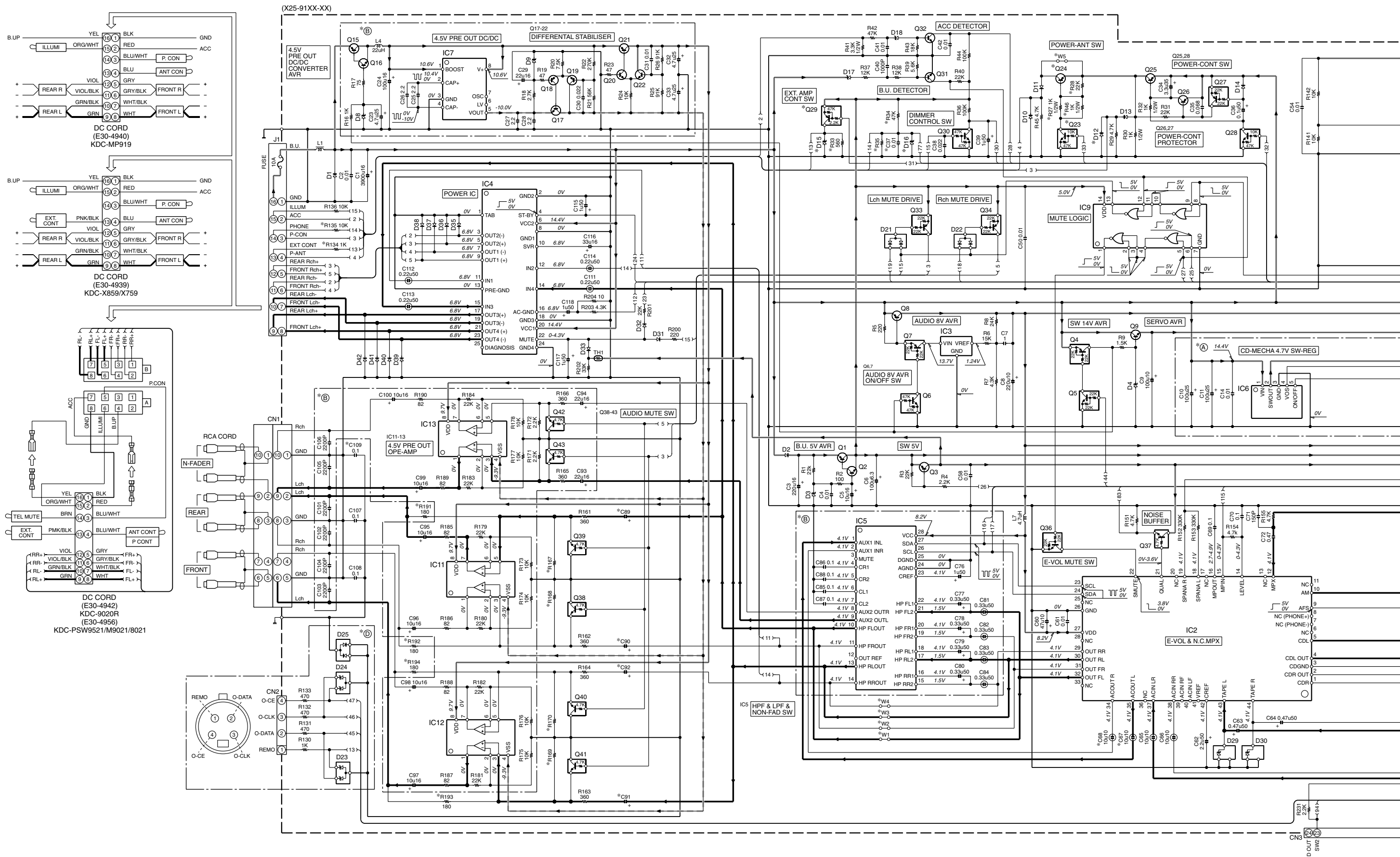

CAUTION: For continued safety, replace safety critical components only with manufacturer's recommended parts (refer to parts list). Δ indicates safety critical components. For continued protection against risk of fire, replace only with same type and rating fuse(s). To reduce the risk of electric shock, leakage-current or resistance measurements shall be carried out (exposed parts are acceptably insulated from the supply circuit) before the appliance is returned to the customer.

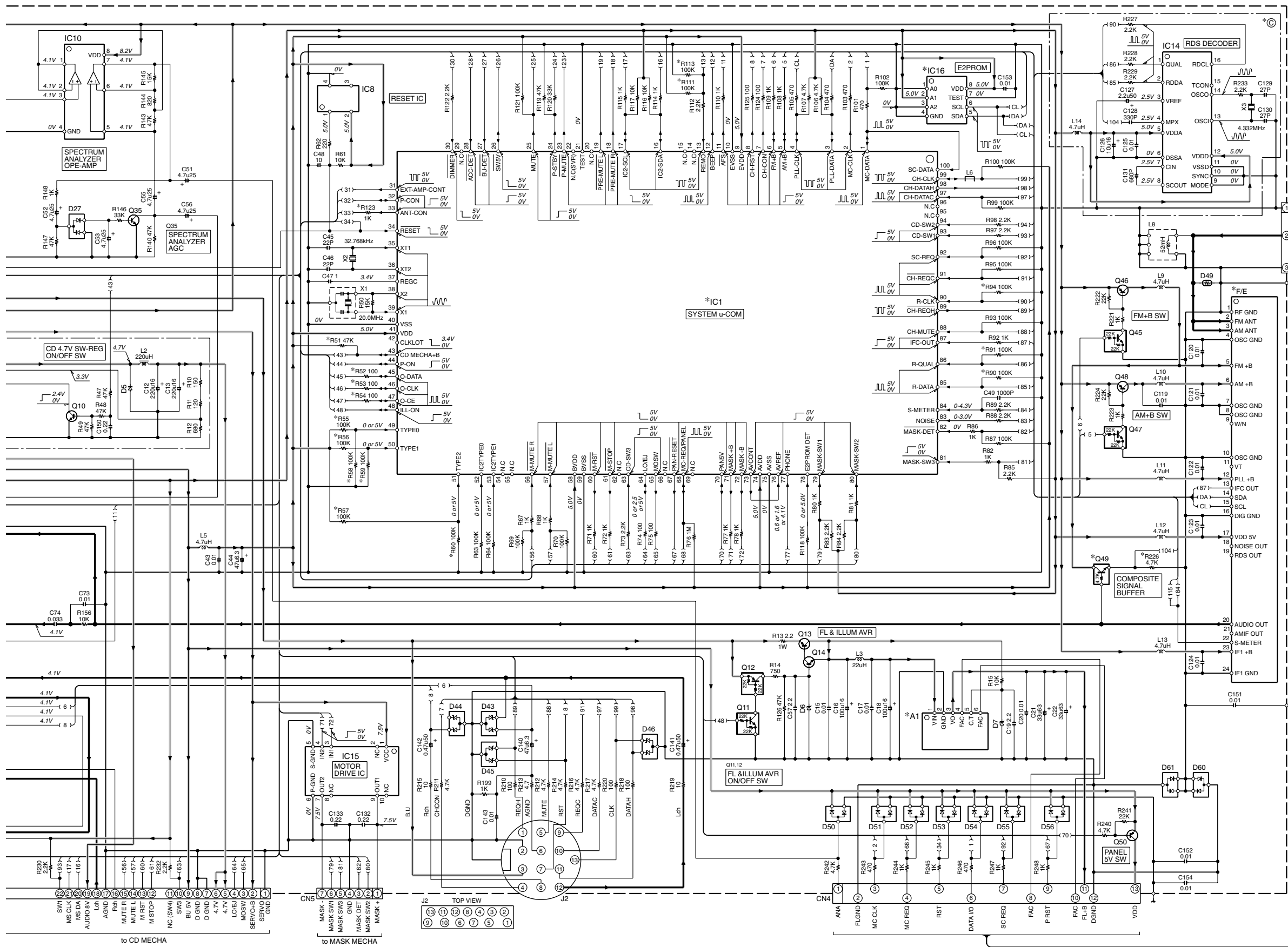

- IC1 : *
- IC2 : TDA7407
- IC3 : MS237ML
- IC4 : TDA7560
- IC5 : TDA7401
- IC6 : S-8033JD
- IC7 : ICL7660SIBA
- IC8 : S-80837ANNP
- IC9 : TC74HC02AF or HD74HC02FP
- IC10-13 : NJM4565M-TE2
- IC14 : SAA6581T
- IC15 : LB1930M
- IC16 : *
- Q1,8,13 : KTA1046
- Q2,10,14,16,17,20,22,31,32,35 : 2SC4081
- Q3,18,19,21,26 : 2SA1576A
- Q4,7,12,27,33,34 : DTA124EUA or KRA303
- Q5,11,36,45,47 : DT124EUA or KRC403
- Q6,10 : DT144EUA or KRC404
- Q9 : 2SD2375
- Q15 : 2SB1443
- Q23,28 : DT114YUA or KRC407
- Q24,25 : 2SB1277 (Q,R)
- Q29 : DTA123JK or KRA105S
- Q37-43,49 : DT143TUA or KRC410
- Q46,48 : 2SB1188(Q,R)
- Q50 : 2SB1427
- D1 : 1N5393G-M5
- D2 : RB160L-40
- D3,9,17 : MA4056(N)-M
- D4 : MA4082(N)-L or HZS9A2L
- D5 : SFPB-54V
- D6 : MA4100-L
- D7 : MA4051(N)-M
- D8 : MA4110(N)-M
- D10-13,35-42 : 1SR154-400
- D14,31-33 : 1SS133
- D15 : MA4056-M
- D16 : MA4047-M or HZS5B1
- D18 : MA4062(N)-M or HZS6C2L
- D21,22 : DAP202U
- D23,24,45,46 : MA3062WA
- D25,27,50-56 : DA204K or KDS226
- D29,30,44 : RD6.8M(B2)
- D43 : RD6.8MW
- D49 : IMSA-6801
- D60,61 : DA204U

(X16-118X-XX)

MODEL NAME	UNIT No.
KDC-X859 (K)	0-10
KDC-9020R (M)	
KDC-X759 (K)	
KDC-MP919 (K)	
KDC-M9021 (E)	2-71
KDC-8021 (E)	
KDC-PSW9521 (E)	

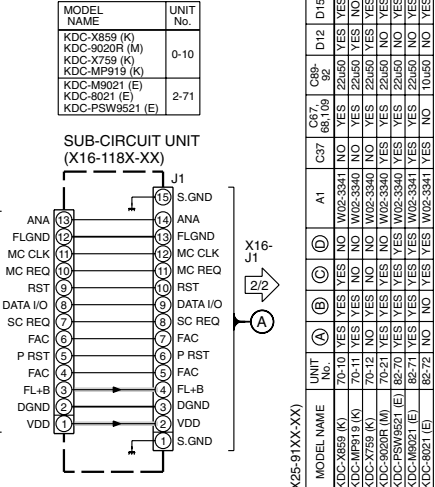

KDC-M9021/8021/X859 (1/2)
KDC-PSW9521/9020R/X759/MP919 (1/2)

KDC-9020R/MP919/PSW9521/X759

KENWOOD

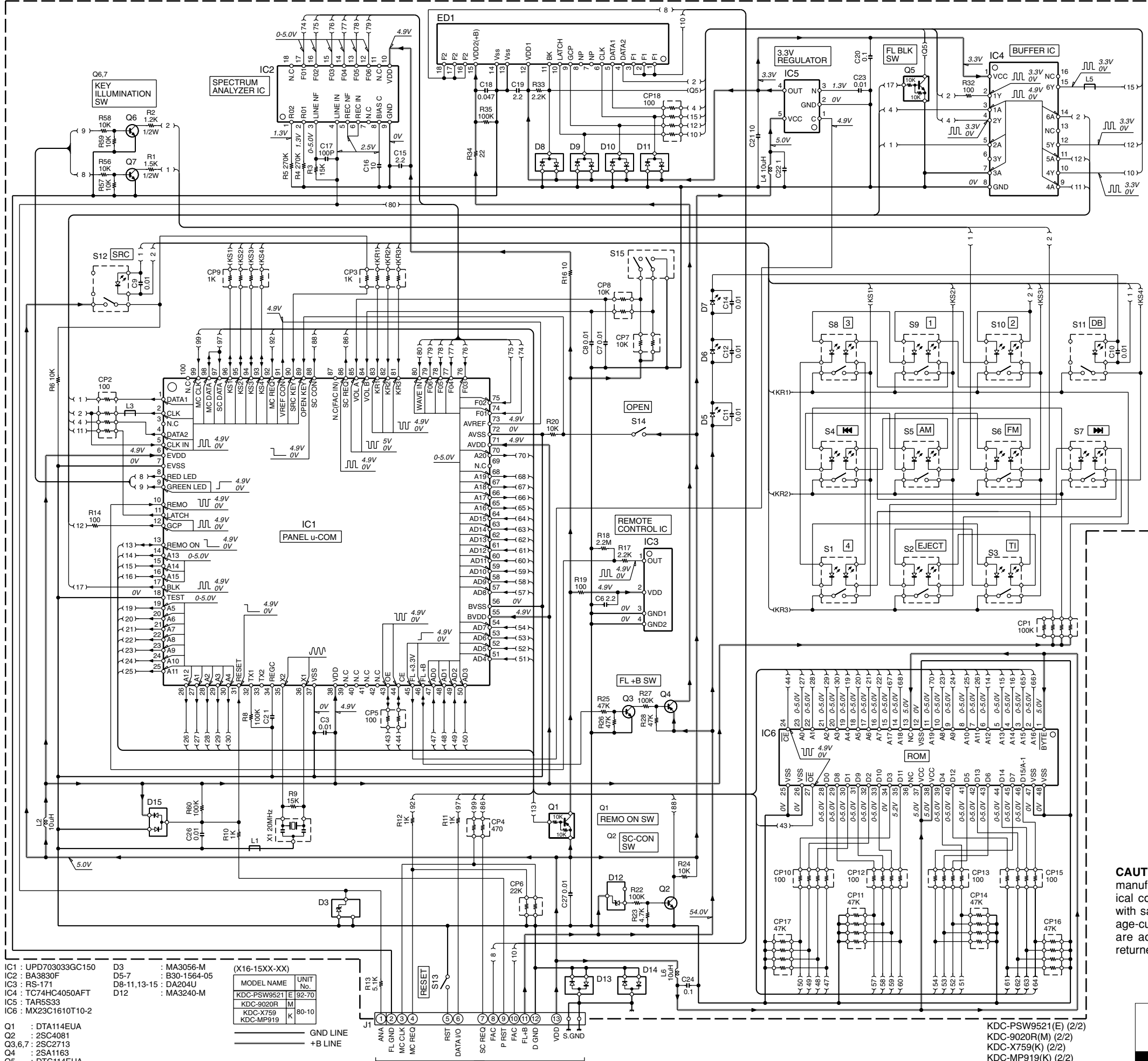

- IC1 : UPD70303GC150
- IC2 : BA3830F
- IC3 : RS-171
- IC4 : TC74HC4050AFT
- IC5 : TAR5S33
- IC6 : MX23C1610T10-2
- IC7 : MA3056-M
- IC8 : B30-1564-05
- IC9 : DA204U
- IC10 : MA3240-M
- D3 : DTC142EUA
- D5-7 : DTC143TUA
- D8-11,13-15 : 2SA1163
- D12 : 2SA1576A
- Q1 : DTA114EUA
- Q2 : 2SC4081
- Q3,6,7 : 2SC2713
- Q4 : 2SA1163
- Q5 : DTC144EUA

MODEL NAME	UNIT
KDC-PSW9521	E 92-70
KDC-9020R	M
KDC-X759	K 80-10
KDC-MP919	K

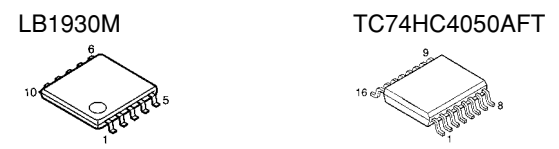
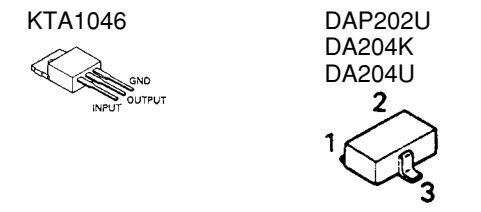
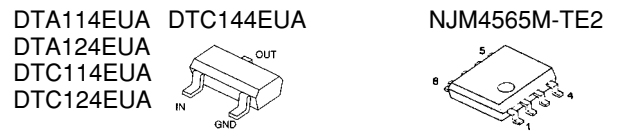
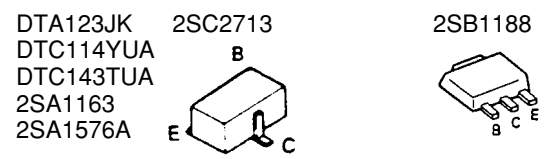
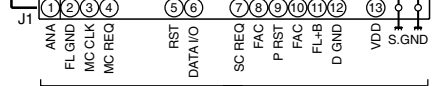
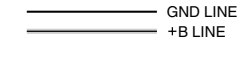

CAUTION: For continued safety, replace safety critical components only with manufacturer's recommended parts (refer to parts list). Δ indicates safety critical components. For continued protection against risk of fire, replace only with same type and rating fuse(s). To reduce the risk of electric shock, leakage-current or resistance measurements shall be carried out (exposed parts are acceptably insulated from the supply circuit) before the appliance is returned to the customer.

KDC-9020R/MP919/PSW9521/X759

KENWOOD

KDC-9020R/MP919/PSW9521/X759

EXPLODED VIEW

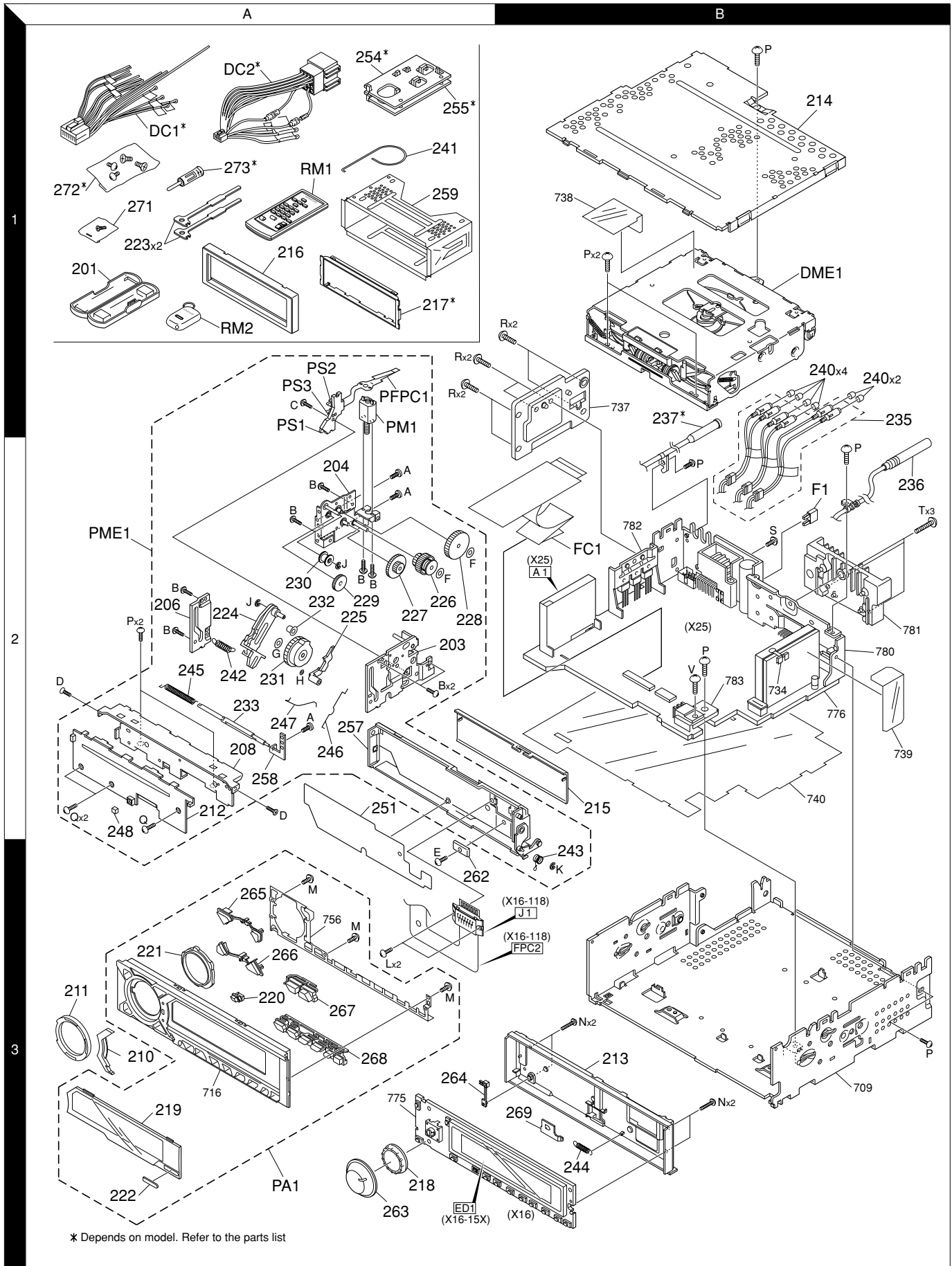

Parts with exploded numbers larger than 700 are not supplied.

KDC-9020R/MP919/PSW9521/X759

PARTS LIST

* New Parts

Parts without **Parts No.** are not supplied.

Les articles non mentionnés dans le **Parts No.** ne sont pas fournis.

Teile ohne **Parts No.** werden nicht geliefert.

Ref.No.	A d d	N e w	Parts No.	Description	Dest inati on	Ref.No.	A d d	N e w	Parts No.	Description	Dest inati on
KDC-9020R/MP919/PSW9521/X759						233	2A		D14-0760-03	ROLLER	
201	1A		A02-1497-13	PLASTIC CABINET ASSY		235	1B	*	E30-6054-05	CORD WITH PINPLUG (3PRE)	K1M1
203	2A		A10-4807-13	CHASSIS CALKING ASSY		235	1B	*	E30-6058-05	CORD WITH PINPLUG (3PRE)	K2
204	2A		A10-4810-13	CHASSIS CALKING ASSY		235	1B	*	E30-6100-05	CORD WITH PINPLUG (3PRE)	E
206	2A		A10-4893-04	CHASSIS CALKING ASSY		236	1B	*	E30-6056-05	CORD WITH PLUG (ANT)	
208	2A		A10-4924-02	CHASSIS		237	2B	*	E30-6057-05	CORD WITH DIN CONNECTOR (DISP)	E
210	3A	*	A21-4169-03	DRESSING PANEL		△ DC1	1A		E30-4939-05	DC CORD	K1
211	3A	*	A21-4170-03	DRESSING PANEL		△ DC1	1A		E30-4940-05	DC CORD	K2
212	2A		A22-2865-03	SUB PANEL ASSY		△ DC2	1A		E30-4942-05	DC CORD (ISO)	M1
213	3B	*	A46-1752-01	REAR COVER		△ DC2	1A		E30-4956-05	DC CORD (ISO)	E
214	1B		A52-0805-02	TOP PLATE		FC1	2B	*	E39-0437-05	FLAT CABLE	
PA1	3A	*	A64-2568-02	PANEL ASSY	K1	240	2B		F29-0049-05	INSULATING COVER	
PA1	3A	*	A64-2569-02	PANEL ASSY	K2	△ F1	2B		F52-0006-05	FUSE(MINI BLADE TYPE)10A	
PA1	3A	*	A64-2570-02	PANEL ASSY	M1	241	1A		G01-2924-04	TORSION COIL SPRING	
PA1	3A	*	A64-2586-02	PANEL ASSY	E	242	2A		G01-3065-04	EXTENSION SPRING	
PME1	2A		A10-4921-02	CHASSIS ASSY		243	2B		G01-3066-14	TORSION COIL SPRING	
RM1	1A		A70-2025-05	REMOTE CONTROLLER ASSY(RC-410)	K1K2	244	3B		G01-3069-04	EXTENSION SPRING	
RM1	1A		A70-2026-05	REMOTE CONTROLLER ASSY(RC-420)	M1E	245	2A		G01-3080-04	TORSION COIL SPRING	
RM2	1A		A70-0886-15	REMOTE CONTROLLER ASSY(MASK)	E	246	2A		G09-2038-04	FORMED WIRE	
215	2B		B03-3073-12	DRESSING PLATE		247	2A		G09-2042-04	FORMED WIRE	
216	1A		B07-3007-03	ESCUTCHEON ASSY		248	2A		G11-1927-04	CUSHION	
217	1C		B07-3010-02	ESCUTCHEON	K1K2M1	251	2A		G16-1177-04	SHEET	
218	3A	*	B09-0527-03	CAP (VOL)		-			H10-4762-12	POLYSTYRENE FOAMED FIXTURE	E
219	3A	*	B10-4149-01	FRONT GLASS	K1	-			H10-4764-12	POLYSTYRENE FOAMED FIXTURE	K1K2M1
219	3A	*	B10-4150-01	FRONT GLASS	K2	-			H25-0329-04	PROTECTION BAG (280X450X0.03)	K1K2M1
219	3A	*	B10-4151-01	FRONT GLASS	M1	-			H25-0337-04	PROTECTION BAG (180X300X0.03)	
219	3A	*	B10-4164-01	FRONT GLASS	E	-			H25-1108-04	PROTECTION BAG (100X300X0.03)	
220	3A	*	B10-4152-04	FRONT GLASS		-			H25-1111-04	PROTECTION BAG (280X450X0.03)	E
221	3A	*	B19-2133-03	LIGHTING BOARD		-		*	H54-2329-03	ITEM CARTON CASE	M1
222	3A		B43-1284-04	BADGE		-		*	H54-2335-03	ITEM CARTON CASE	E
-			B46-0100-50	WARRANTY CARD		-		*	H54-2342-13	ITEM CARTON CASE	K1
-			B46-0606-04	ID CARD	K1K2	-		*	H54-2343-03	ITEM CARTON CASE	K2
-			B46-0612-14	ID CARD	M1						
-			B46-0632-04	ID CARD	E	254	1A		J19-5051-03	BRACKET (L)	K1K2M1
-			B46-0645-03	USER CARD	K1K2	255	1A		J19-5052-03	BRACKET (R)	K1K2M1
-	*		B46-0648-03	USER CARD	K1	257	2A		J21-9651-13	MOUNTING HARDWARE ASSY	
-			B58-1309-04	CAUTION CARD	E	258	2A		J21-9699-04	MOUNTING HARDWARE	
-	*		B64-2215-00	INSTRUCTION MANUAL (ENGLISH)	K1K2	259	1A		J21-9716-03	MOUNTING HARDWARE ASSY	
-	*		B64-2216-00	INSTRUCTION MANUAL (FRE.SPA.)	K1K2	262	3B		J90-0999-04	GUIDE	
-	*		B64-2217-00	INSTRUCTION MANUAL (ENG.T-CHI)	M1	PFPC1	1A		J84-0122-04	FLEXIBLE PRINTED WIRING BOARD	
-	*		B64-2218-00	INSTRUCTION MANUAL (ENGLISH)	E	263	3A	*	K23-1062-03	KNOB (VOL)	
-	*		B64-2219-00	INSTRUCTION MANUAL (FRE.GER.)	E	264	3A	*	K24-3646-04	KNOB (RESET)	
-	*		B64-2220-00	INSTRUCTION MANUAL (DUT.ITA.)	E	265	3A	*	K25-1400-03	KNOB (FM/AM)	
-	*		B64-2221-00	INSTRUCTION MANUAL (SPA.POR.)	E	266	3A	*	K25-1401-03	KNOB (UP/DOWN)	
223	1A		D10-4562-04	LEVER		267	3A	*	K25-1402-03	KNOB (SRC)	
224	2A		D10-4563-04	ARM ASSY		268	3A	*	K25-1403-03	KNOB (PRESET)	
225	2A		D10-4590-04	ARM		269	3B		K29-7017-03	KNOB (LOCK)	
226	2A		D13-2135-04	GEAR ASSY		271	1A		N99-1704-05	SCREW SET	
227	2A		D13-2138-04	GEAR		272	1A		N99-1722-05	SCREW SET	K1K2M1
228	2A		D13-2139-04	GEAR		A	2A		N09-4400-05	MACHINE SCREW	
229	2A		D13-2140-04	GEAR		B	2A		N09-4401-05	MACHINE SCREW	
230	2A		D13-2141-14	GEAR ASSY		C	1A		N09-4427-05	TAPTITE SCREW	
231	2A		D13-2165-03	GEAR ASSY		D	2A		N09-4448-05	MACHINE SCREW	
232	2A		D14-0754-04	ROLLER							

E : KDC-PSW9521

M1 : KDC-9020R

K1 : KDC-X759

K2 : KDC-MP919

E: Europe K: North America M: Other Areas

W: Without Europe

△ indicates safety critical components.

PARTS LIST

* New Parts

Parts without **Parts No.** are not supplied.

Les articles non mentionnés dans le **Parts No.** ne sont pas fournis.

Teile ohne **Parts No.** werden nicht geliefert.

Ref.No.	A d d	N e w	Parts No.	Description	Dest inati on	Ref.No.	A d d	N e w	Parts No.	Description	Dest inati on
E	3A		N09-4449-05	MACHINE SCREW		L5			L92-0332-05	CHIP FERRITE	
F	2A		N19-2154-04	FLAT WASHER		L6			L40-1005-34	SMALL FIXED INDUCTOR	
G	2A		N19-2155-04	FLAT WASHER		L6			L40-1005-68	SMALL FIXED INDUCTOR	
H	2A		N19-2156-04	FLAT WASHER		X1			L78-0821-05	RESONATOR	
J	2A		N29-0522-05	RETAINING RING		CP1			R90-0720-05	MULTI-COMP 100K X4	
K	3B		N29-0523-05	RETAINING RING		CP2			R90-1014-05	MULTI-COMP 100 X4	
L	3A		N38-2025-46	PAN HEAD MACHIN SCREW		CP3			R90-0724-05	MULTI-COMP 1K X4	
M	3A		N80-2005-46	PAN HEAD TAPTITE SCREW		CP4			R90-1022-05	MULTI-COMP 470 X2	
N	3B		N09-4473-05	MACHINE SCREW		CP5			R90-1019-05	MULTI-COMP 100 X2	
P	1B		N83-3005-46	PAN HEAD TAPTITE SCREW		CP6			R90-1020-05	MULTI-COMP 22K X2	
Q	2A		N86-2004-45	BINDING HEAD TAPTITE SCREW		CP7 ,8			R90-0726-05	MULTI-COMP 10K X2	
R	1A		N83-3008-46	PAN HEAD TAPTITE SCREW		CP9			R90-0724-05	MULTI-COMP 1K X4	
PS1 -3	1A		S68-0856-05	PUSH SWITCH		CP10			R90-1014-05	MULTI-COMP 100 X4	
273	1A		T90-0523-05	ANTENNA ADAPTOR	M1E	CP11			R90-0748-05	MULTI-COMP 47K X4	
273	1A		T90-0534-05	ANTENNA ADAPTOR	M1E	CP12,13			R90-1014-05	MULTI-COMP 100 X4	
PM1	1A		T42-1034-04	MOTOR ASSY		CP14			R90-0748-05	MULTI-COMP 47K X4	
DME1	1B		X92-4450-00	CD MECHANISM ASSY (DXM-6110W)	K1	CP15			R90-1014-05	MULTI-COMP 100 X4	
DME1	1B		X92-4460-00	CD MECHANISM ASSY (DXM-6400W)	K2	CP16,17			R90-0748-05	MULTI-COMP 47K X4	
DME1	1B	*	X92-4470-00	CD MECHANISM ASSY (DXM-6500W)	M1	CP18			R90-1014-05	MULTI-COMP 100 X4	
DME1	1B	*	X92-4470-01	CD MECHANISM ASSY (DXM-6501W)	E	R1			R92-2072-05	CHIP R 1.5K J 1/2W	
SUB-CIRCUIT UNIT (X16-118x-xx)						R2			R92-2565-05	CHIP R 1.2K J 1/2W	
J1	3B		E58-0903-05	RECTANGULAR RECEPTACLE		R3			RK73GB2A153J	CHIP R 15K J 1/10W	
FPC2	3B	*	J84-0121-12	FLEXIBLE PRINTED WIRING BOARD		R4 ,5	*		RK73GB2A274J	CHIP R 270K J 1/10W	
SWITCH UNIT (X16-15xx-xx)						R6			RK73GB2A103J	CHIP R 10K J 1/10W	
D5 -7			B30-1564-05	LED(1608,BLUE)		R8			RK73GB2A104J	CHIP R 100K J 1/10W	
C2			CK73GB0J105K	CHIP C 1.0UF K		R9			RK73GB2A153J	CHIP R 15K J 1/10W	
C3			CK73GB1H103K	CHIP C 0.010UF K		R10 -12			RK73GB2A102J	CHIP R 1.0K J 1/10W	
C6			CK73FB1A225K	CHIP C 2.2UF K		R13			RK73GB2A512J	CHIP R 5.1K J 1/10W	
C7 -12			CK73GB1H103K	CHIP C 0.010UF K		R14			RK73GB2A101J	CHIP R 100 J 1/10W	
C14			CK73GB1H103K	CHIP C 0.010UF K		R16			RK73GB2A100J	CHIP R 10 J 1/10W	
C15			CK73FB1A225K	CHIP C 2.2UF K		R17			RK73GB2A222J	CHIP R 2.2K J 1/10W	
C16			CK73EBOJ106K	CHIP C 10UF K		R18			RK73GB2A225J	CHIP R 2.2M J 1/10W	
C17			CC73GC1H101J	CHIP C 100PF J		R19			RK73GB2A101J	CHIP R 100 J 1/10W	
C18			C93-1217-05	CHIP C 0.047UF K		R20			RK73GB2A103J	CHIP R 10K J 1/10W	
C19			CK73FB1A225K	CHIP C 2.2UF K		R22			RK73GB2A104J	CHIP R 100K J 1/10W	
C20			CK73GB1C104K	CHIP C 0.10UF K		R23			RK73GB2A472J	CHIP R 4.7K J 1/10W	
C20			CK73GB1H104K	CHIP C 0.10UF K		R24			RK73GB2A103J	CHIP R 10K J 1/10W	
C21			CK73EBOJ106K	CHIP C 10UF K		R25 ,26			RK73GB2A473J	CHIP R 47K J 1/10W	
C22			CK73GB0J105K	CHIP C 1.0UF K		R27			RK73GB2A104J	CHIP R 100K J 1/10W	
C23			CK73GB1H103K	CHIP C 0.010UF K		R28			RK73GB2A473J	CHIP R 47K J 1/10W	
C24			CK73GB1C104K	CHIP C 0.10UF K		R32			RK73GB2A101J	CHIP R 100 J 1/10W	
C24			CK73GB1H104K	CHIP C 0.10UF K		R33			RK73GB2A222J	CHIP R 2.2K J 1/10W	
C26 ,27			CK73GB1H103K	CHIP C 0.010UF K		R34	*		RK73GB2A220J	CHIP R 22 J 1/10W	
J1			E59-0835-05	RECTANGULAR PLUG		R56 -59			RK73GB2A103J	CHIP R 10K J 1/10W	
L1			L92-0332-05	CHIP FERRITE		R60			RK73GB2A104J	CHIP R 100K J 1/10W	
L2			L40-1005-34	SMALL FIXED INDUCTOR		S1 -10			S70-0856-05	TACT SWITCH	
L2			L40-1005-68	SMALL FIXED INDUCTOR		S11 ,12			S70-0857-05	TACT SWITCH	
L3			L92-0332-05	CHIP FERRITE		S13			S70-0851-05	TACT SWITCH	
L4			L40-1005-34	SMALL FIXED INDUCTOR		S14			S70-0864-05	TACT SWITCH	
L4			L40-1005-68	SMALL FIXED INDUCTOR		S15	*		T99-0431-05	ROTARY ENCODER	
						D3			HZM5.6N(B2)	ZENER DIODE	K1K2M1
						D3			MA3056-M	ZENER DIODE	
						D3			02CZ5.6-Y	ZENER DIODE	K1K2M1

E : KDC-PSW9521

M1 : KDC-9020R

K1 : KDC-X759

K2 : KDC-MP919

E: Europe K: North America M: Other Areas

W: Without Europe

indicates safety critical components.

PARTS LIST

* New Parts

Parts without **Parts No.** are not supplied.

Les articles non mentionnés dans le **Parts No.** ne sont pas fournis.

Teile ohne **Parts No.** werden nicht geliefert.

Ref.No.	A d d	N e w	Parts No.	Description	Dest inati on	Ref.No.	A d d	N e w	Parts No.	Description	Dest inati on		
D8 -11			DA204U	DIODE		C41 -43			CK73GB1H103K	CHIP C	0.010UF	K	
D12		*	MA3240-M	ZENER DIODE		C44			CE04NW0J470M	ELECTRO	47UF	6.3WV	
D13 -15			DA204U	DIODE		C45, 46			CC73GCH1H220J	CHIP C	22PF	J	
ED1		*	MN16826A	FLUORESCENT INDICATOR TUBE		C47			CK73GB0J105K	CHIP C	1.0UF	K	
IC1		*	UPD703033GC150	MI-COM IC		C48			CK73EB0J106K	CHIP C	10UF	K	
IC2			BA3830F	ANALOGUE IC		C49			CK73GB1H102K	CHIP C	1000PF	K	
IC3			RS-171	ANALOGUE IC		C50			CK73GB1H103K	CHIP C	0.010UF	K	
IC4			TC74HC4050AFT	MOS-IC		C51 -53			CE04NW1E4R7M	ELECTRO	4.7UF	25WV	
IC5		*	TAR5S33	ANALOGUE IC		C54			CK73GB1H103K	CHIP C	0.010UF	K	
IC6		*	MX23C1610T10-2	MEMORY IC		C55, 56			CE04NW1E4R7M	ELECTRO	4.7UF	25WV	
Q1			DTA114EUA	DIGITAL TRANSISTOR		C60			CE04NW1C470M	ELECTRO	47UF	16WV	
Q1			KRA302	DIGITAL TRANSISTOR	K1K2M1	C61			CK73GB1H103K	CHIP C	0.010UF	K	
Q2			2SC4081	TRANSISTOR		C62			CE04NW1H2R2M	ELECTRO	2.2UF	50WV	
Q3			2SC2713	TRANSISTOR		C63, 64			CE04NW1HR47M	ELECTRO	0.47UF	50WV	
Q4			2SA1163	TRANSISTOR		C65 -68			C90-2850-05	ELECTRO	10UF	10WV	
Q5			DTC114EUA	DIGITAL TRANSISTOR		C69, 70			CK73GB1C104K	CHIP C	0.10UF	K	
Q5			KRC402	DIGITAL TRANSISTOR	K1K2M1	C69, 70			CK73GB1H104K	CHIP C	0.10UF	K	
Q6, 7			2SC2713	TRANSISTOR		C71			CC73GCH1H151J	CHIP C	150PF	J	
ELECTRIC UNIT (X25-91xx-xx)						C72			CK73GB1A474K	CHIP C	0.47UF	K	
C1			C90-5377-05	ELECTRO	3900UF	16WV			CK73GB1H103K	CHIP C	0.010UF	K	
C2			CK73GB1H103K	CHIP C	0.010UF	K			CK73GB1E333K	CHIP C	0.033UF	K	
C3			C90-2866-05	ELECTRO	220UF	16WV			CK73GB1H333K	CHIP C	0.033UF	K	
C4			CK73GB1H103K	CHIP C	0.010UF	K			CE04NW1H010M	ELECTRO	1.0UF	50WV	
C5			CE04NW1C100M	ELECTRO	10UF	16WV			CE04NW1HR33M	ELECTRO	0.33UF	50WV	
C6			CE04NW0J101M	ELECTRO	100UF	6.3WV		*	C90-5429-05	ELECTRO	0.33UF	50WV	
C7			CK73FB1C105K	CHIP C	1.0UF	K			CK73GB1C104K	CHIP C	0.10UF	K	
C8			CE04CW1A221M	ELECTRO	220UF	10WV			CK73GB1H104K	CHIP C	0.10UF	K	
C9			CE04CW1A101M	ELECTRO	100UF	10WV			CE04CW1C220M	ELECTRO	22UF	16WV	
C10, 11			C90-2963-05	ELECTRO	100UF	25WV			CE04NW1C100M	ELECTRO	10UF	16WV	
C12, 13			C90-5418-05	ELECTRO	220UF	16WV			CK73GB1H222K	CHIP C	2200PF	K	
C14, 15			CK73GB1H103K	CHIP C	0.010UF	K			CK73FB1H104K	CHIP C	0.10UF	K	
C15			CK73GB1H103K	CHIP C	0.010UF	K			C90-5296-05	NP-ELECT	0.22UF	50WV	
C16			C90-2962-05	ELECTRO	100UF	16WV			CE04NW1H010M	ELECTRO	1.0UF	50WV	
C17			CK73GB1H103K	CHIP C	0.010UF	K			CE04NW1C330M	ELECTRO	33UF	16WV	
C18			C90-2962-05	ELECTRO	100UF	16WV			CE04NW1H010M	ELECTRO	1.0UF	50WV	
C19			CK73FB1A225K	CHIP C	2.2UF	K			C90-2935-05	ELECTRO	1.0UF	50WV	
C20		*	C93-1218-05	CHIP C	0.010UF	K			CK73GB1H103K	CHIP C	0.010UF	K	
C21, 22			C90-5375-05	ELECTRO	33UF	63WV			CK73GB1H103K	CHIP C	0.010UF	K	
C23			CE04NW1E4R7M	ELECTRO	4.7UF	25WV			CE04NW1C100M	ELECTRO	10UF	16WV	
C24			C90-2962-05	ELECTRO	100UF	16WV			CE04NW1H2R2M	ELECTRO	2.2UF	50WV	
C25 -28			CK73EB1C225K	CHIP C	2.2UF	K			C128	CC73GCH1H331J	CHIP C	330PF	J
C29			CE04NW1C220M	ELECTRO	22UF	16WV			C129,130	CC73GCH1H270J	CHIP C	27PF	J
C30			CK73GB1E223K	CHIP C	0.022UF	K			C131	CC73GCH1H681J	CHIP C	680PF	J
C30			CK73GB1H223K	CHIP C	0.022UF	K			C132,133	CK73GB1A224K	CHIP C	0.22UF	K
C31			CK73GB1H103K	CHIP C	0.010UF	K			C140	CE04NW0J470M	ELECTRO	47UF	6.3WV
C32, 33			CE04NW1E4R7M	ELECTRO	4.7UF	25WV			C141,142	CE04NW1HR47M	ELECTRO	0.47UF	50WV
C34			CE04NW1V3R3M	ELECTRO	3.3UF	35WV			C143	CK73GB1H103K	CHIP C	0.010UF	K
C35			CK73GB1C683K	CHIP C	0.068UF	K			C150	CK73GB1A224K	CHIP C	0.22UF	K
C36			CE04NW1H0R1M	ELECTRO	0.1UF	50WV			C151-153	CK73GB1H103K	CHIP C	0.010UF	K
C37			CK73GB1H103K	CHIP C	0.010UF	K			CN1	* E41-0174-05	PIN ASSY		
C38			CK73GB1E223K	CHIP C	0.022UF	K			CN2	E40-3248-05	PIN ASSY		
C38			CK73GB1H223K	CHIP C	0.022UF	K			CN3	E40-9527-05	FLAT CABLE CONNECTOR		
C39			CE04NW1H010M	ELECTRO	1.0UF	50WV			CN3	* E41-0213-05	FLAT CABLE CONNECTOR		
C40			CK73GB1H102K	CHIP C	1000PF	K			CN4	E40-9557-05	FLAT CABLE CONNECTOR		

E : KDC-PSW9521

E: Europe K: North America M: Other Areas
W: Without Europe

M1 : KDC-9020R

K1 : KDC-X759

K2 : KDC-MP919

⚠ indicates safety critical components.

KDC-9020R/MP919/PSW9521/X759

PARTS LIST

* New Parts

Parts without **Parts No.** are not supplied.

Les articles non mentionnés dans le **Parts No.** ne sont pas fournis.

Teile ohne **Parts No.** werden nicht geliefert.

ELECTRIC UNIT (X25-91xx-xx)

Ref.No.	A d d	N e w	Parts No.	Description	Dest inati on	Ref.No.	A d d	N e w	Parts No.	Description	Dest inati on
△ CN5			E40-5031-05	FLAT CABLE CONNECTOR		R35 ,36			RK73GB2A104J	CHIP R 100K J 1/10W	K1K2
J1			E58-0863-15	RECTANGULAR RECEPTACLE		R36			RK73GB2A104J	CHIP R 100K J 1/10W	M1E
J2			E56-0834-05	CYLINDRICAL RECEPTACLE		R37			RK73FB2B123J	CHIP R 12K J 1/8W	
J3			E04-0154-05	RF COAXIAL CABLE RECEPTACLE		R38			RK73GB2A123J	CHIP R 12K J 1/10W	
L1			L33-1170-05	CHOKO COIL ASSY		R39			RK73GB2A562J	CHIP R 5.6K J 1/10W	
L2			L33-1819-05	CHOKO COIL	K2M1E	R40			RK73GB2A223J	CHIP R 22K J 1/10W	
L3			L33-1029-05	SMALL FIXED INDUCTOR		R41			RD14DB2H332J	SMALL-RD 3.3K J 1/2W	
L4			L40-2205-91	SMALL FIXED INDUCTOR(22UH,J)		R43			RK73GB2A183J	CHIP R 18K J 1/10W	
L5			L40-4795-91	SMALL FIXED INDUCTOR(4.7UH,J)		R44			RK73GB2A104J	CHIP R 100K J 1/10W	
L6			L92-0075-05	CHIP FERRITE		R45			RK73FB2B472J	CHIP R 4.7K J 1/8W	
L7			L40-4795-91	SMALL FIXED INDUCTOR(4.7UH,J)		R46			RD14DB2H102J	SMALL-RD 1.0K J 1/2W	K1K2
L8			L33-1039-05	LINE FILTER COIL		R47 -49			RK73GB2A473J	CHIP R 47K J 1/10W	K2M1E
L9 -13			L40-4795-91	SMALL FIXED INDUCTOR(4.7UH,J)	K1K2	R50			RK73GB2A153J	CHIP R 15K J 1/10W	
L9 -14			L40-4795-91	SMALL FIXED INDUCTOR(4.7UH,J)	M1E	R51			RK73GB2A473J	CHIP R 47K J 1/10W	K2M1E
X1			L78-0821-05	RESONATOR		R52 -54			RK73GB2A101J	CHIP R 100 J 1/10W	E
X2			L77-2738-05	CRYSTAL RESONATOR		R55			RK73GB2A104J	CHIP R 100K J 1/10W	K1E
X3			L77-2002-05	CRYSTAL RESONATOR	M1E	R55 ,56			RK73GB2A104J	CHIP R 100K J 1/10W	K2
S	2B		N80-3008-46	PAN HEAD TAPTITE SCREW		R57			RK73GB2A104J	CHIP R 100K J 1/10W	K1
T	2B		N83-3016-46	PAN HEAD TAPTITE SCREW		R58 -60			RK73GB2A104J	CHIP R 100K J 1/10W	M1
V	2B		N86-2606-46	BINDING HEAD TAPTITE SCREW		R59			RK73GB2A104J	CHIP R 100K J 1/10W	K1
R1			RK73FB2B223J	CHIP R 22K J 1/8W		R59 ,60			RK73GB2A104J	CHIP R 100K J 1/10W	E
R2			RK73GB2A101J	CHIP R 100 J 1/10W		R60			RK73GB2A104J	CHIP R 100K J 1/10W	K2
R3			RK73GB2A223J	CHIP R 22K J 1/10W		R61			RK73GB2A103J	CHIP R 10K J 1/10W	
R4			RK73GB2A222J	CHIP R 2.2K J 1/10W		R62			RK73GB2A221J	CHIP R 220 J 1/10W	
R5			RK73FB2B221J	CHIP R 220 J 1/8W		R63 ,64			RK73GB2A104J	CHIP R 100K J 1/10W	
R6			RK73GB2A153J	CHIP R 15K J 1/10W		R67 ,68			RK73GB2A102J	CHIP R 1.0K J 1/10W	
R7			R92-3032-05	CHIP R 4.3K D 1/10W		R69 ,70			RK73GB2A104J	CHIP R 100K J 1/10W	
R8			R92-3047-05	CHIP R 24K D 1/10W		R71 ,72			RK73GB2A102J	CHIP R 1.0K J 1/10W	
R9			RK73GB2A152J	CHIP R 1.5K J 1/10W		R73			RK73GB2A222J	CHIP R 2.2K J 1/10W	
R10		*	R92-3018-05	CHIP R 150 D 1/10W	K2M1E	R74 ,75			RK73GB2A101J	CHIP R 100 J 1/10W	
R11		*	R92-3017-05	CHIP R 120 D 1/10W	K2M1E	R76			RK73GB2A105J	CHIP R 1.0M J 1/10W	
R12		*	R92-3021-05	CHIP R 680 D 1/10W	K2M1E	R77 ,78			RK73GB2A102J	CHIP R 1.0K J 1/10W	
R13			R92-2104-05	CHIP R 2.2 J 1W		R79			RK73GB2A104J	CHIP R 100K J 1/10W	
R14			RK73GB2A152J	CHIP R 1.5K J 1/10W		R80 -82			RK73GB2A102J	CHIP R 1.0K J 1/10W	
R15			RK73FB2B103J	CHIP R 10K J 1/8W		R83 -85			RK73GB2A222J	CHIP R 2.2K J 1/10W	
R16			RK73GB2A102J	CHIP R 1.0K J 1/10W		R86			RK73GB2A102J	CHIP R 1.0K J 1/10W	
R17			RK73GB2A750J	CHIP R 75 J 1/10W		R87			RK73GB2A104J	CHIP R 100K J 1/10W	
R18			RK73GB2A272J	CHIP R 2.7K J 1/10W		R88 ,89			RK73GB2A222J	CHIP R 2.2K J 1/10W	
R19			RK73GB2A470J	CHIP R 47 J 1/10W		R90 ,91			RK73GB2A104J	CHIP R 100K J 1/10W	K1K2
R20			RK73GB2A752J	CHIP R 7.5K J 1/10W		R92			RK73GB2A102J	CHIP R 1.0K J 1/10W	
R21			RK73GB2A563J	CHIP R 56K J 1/10W		R93			RK73GB2A104J	CHIP R 100K J 1/10W	M1E
R22		*	RK73GB2A274J	CHIP R 270K J 1/10W		R93 -96			RK73GB2A104J	CHIP R 100K J 1/10W	K1K2
R23			RK73GB2A470J	CHIP R 47 J 1/10W		R95 ,96			RK73GB2A104J	CHIP R 100K J 1/10W	M1E
R24			RK73GB2A103J	CHIP R 10K J 1/10W		R97 ,98			RK73GB2A222J	CHIP R 2.2K J 1/10W	
R25 ,26			RK73GB2A913J	CHIP R 91K J 1/10W		R99 ,100			RK73GB2A104J	CHIP R 100K J 1/10W	
R27			RD14DB2H102J	SMALL-RD 1.0K J 1/2W	K1K2	R101			RK73GB2A471J	CHIP R 470 J 1/10W	
R28			RK73GB2A223J	CHIP R 22K J 1/10W	K1K2	R102			RK73GB2A104J	CHIP R 100K J 1/10W	
R29			RK73FB2B472J	CHIP R 4.7K J 1/8W		R103-105			RK73GB2A471J	CHIP R 470 J 1/10W	
R30			RD14DB2H102J	SMALL-RD 1.0K J 1/2W		R106,107			RK73GB2A472J	CHIP R 4.7K J 1/10W	
R31			RK73GB2A223J	CHIP R 22K J 1/10W		R108-110			RK73GB2A102J	CHIP R 1.0K J 1/10W	
R32			RD14DB2H102J	SMALL-RD 1.0K J 1/2W		R111			RK73GB2A104J	CHIP R 100K J 1/10W	E
R33			RK73FB2B561J	CHIP R 560 J 1/8W	K1M1E	R112			RK73GB2A222J	CHIP R 2.2K J 1/10W	
R34			RK73GB2A473J	CHIP R 47K J 1/10W	M1E	R113			RK73GB2A104J	CHIP R 100K J 1/10W	K1K2M1
R35			RK73GB2A223J	CHIP R 22K J 1/10W	M1E	R114,115			RK73GB2A102J	CHIP R 1.0K J 1/10W	
						R116,117			RK73GB2A103J	CHIP R 10K J 1/10W	

E : KDC-PSW9521

M1 : KDC-9020R

K1 : KDC-X759

K2 : KDC-MP919

E: Europe K: North America M: Other Areas

W: Without Europe

△ indicates safety critical components.

KDC-9020R/MP919/PSW9521/X759

PARTS LIST

* New Parts

Parts without **Parts No.** are not supplied.

Les articles non mentionnés dans le **Parts No.** ne sont pas fournis.

Teile ohne **Parts No.** werden nicht geliefert.

ELECTRIC UNIT (X25-91xx-xx)

Ref.No.	A d d	N e w	Parts No.	Description	Dest inati on	Ref.No.	A d d	N e w	Parts No.	Description	Dest inati on
R119			RK73GB2A473J	CHIP R 47K J 1/10W		R242			RK73EB2E472J	CHIP R 4.7K J 1/4W	
R120			RK73GB2A333J	CHIP R 33K J 1/10W		R243			RK73EB2E471J	CHIP R 470 J 1/4W	
R121			RK73GB2A104J	CHIP R 100K J 1/10W		R244,245			RK73EB2E102J	CHIP R 1.0K J 1/4W	
R122			RK73GB2A222J	CHIP R 2.2K J 1/10W		R246			RK73EB2E471J	CHIP R 470 J 1/4W	
R130			RK73EB2E102J	CHIP R 1.0K J 1/4W	E	R247,248			RK73EB2E102J	CHIP R 1.0K J 1/4W	
R131-133			RK73EB2E471J	CHIP R 470 J 1/4W	E	W5			R92-1252-05	CHIP R 0 OHM J 1/16W	M1E
R134			RK73EB2E102J	CHIP R 1.0K J 1/4W	K1M1E	D1			1N5393G-M5	DIODE	
R135,136			RK73EB2E103J	CHIP R 10K J 1/4W	M1E	D2			RB160L-40	DIODE	
R136			RK73EB2E103J	CHIP R 10K J 1/4W	K1K2	D3			MA4056(N)-M	ZENER DIODE	
R140			RK73GB2A473J	CHIP R 47K J 1/10W		D4			HZS9A2L	ZENER DIODE	K1K2M1
R141,142			RK73GB2A103J	CHIP R 10K J 1/10W		D4			MA4082(N)-L	ZENER DIODE	
R143			RK73GB2A473J	CHIP R 47K J 1/10W		D5			SFPB-54V	DIODE	K2M1E
R144		*	RK73GB2A821J	CHIP R 820 J 1/10W		D6			MA4100-L	ZENER DIODE	
R145			RK73GB2A153J	CHIP R 15K J 1/10W		D7			MA4051(N)-M	ZENER DIODE	
R146			RK73GB2A333J	CHIP R 33K J 1/10W		D8			MA4110(N)-M	ZENER DIODE	
R147			RK73GB2A473J	CHIP R 47K J 1/10W		D9			MA4056(N)-M	ZENER DIODE	
R148			RK73GB2A102J	CHIP R 1.0K J 1/10W		D10,11			1SR154-400	DIODE	
R151			RK73GB2A472J	CHIP R 4.7K J 1/10W		D13			1SR154-400	DIODE	
R152,153			RK73GB2A334J	CHIP R 330K J 1/10W		D14			1SS133	DIODE	
R154,155			RK73GB2A472J	CHIP R 4.7K J 1/10W		D15			MA4056-M	ZENER DIODE	K1M1E
R156			RK73GB2A103J	CHIP R 10K J 1/10W		D16			HZS5B1	ZENER DIODE	M1
R161-164			RK73FB2B361J	CHIP R 360 J 1/8W		D16			MA4047-M	ZENER DIODE	M1E
R165,166			RK73GB2A361J	CHIP R 360 J 1/10W		D17			MA4056(N)-M	ZENER DIODE	
R167-170			RK73FB2B222J	CHIP R 2.2K J 1/8W		D18			HZS6C2L	ZENER DIODE	K1K2M1
R171,172			RK73GB2A222J	CHIP R 2.2K J 1/10W		D18			MA4062(N)-M	ZENER DIODE	
R173-176			RK73FB2B103J	CHIP R 10K J 1/8W		D21,22			DAP202U	DIODE	
R177,178			RK73GB2A103J	CHIP R 10K J 1/10W		D23,24			MA3062WA	ZENER DIODE	E
R179-182			RK73FB2B223J	CHIP R 22K J 1/8W		D25			DA204K	DIODE	E
R183,184			RK73GB2A223J	CHIP R 22K J 1/10W		D27			DA204K	DIODE	
R185-188		*	RK73FB2B820J	CHIP R 82 J 1/8W		D27			KDS226	DIODE	K1K2M1
R189,190		*	RK73GB2A820J	CHIP R 82 J 1/10W		D29,30			RD6.8M(B2)	ZENER DIODE	
R199			RK73GB2A102J	CHIP R 1.0K J 1/10W		D31-33			1SS133	DIODE	
R200			RK73GB2A221J	CHIP R 220 J 1/10W		D35-42			1SR154-400	DIODE	
R201			RK73GB2A223J	CHIP R 22K J 1/10W		D43			RD6.8MW	ZENER DIODE	
R202			RK73GB2A333J	CHIP R 33K J 1/10W		D44			RD6.8M(B2)	ZENER DIODE	
R203			RK73GB2A432J	CHIP R 4.3K J 1/10W		D45,46			MA3062WA	ZENER DIODE	
R204			RK73GB2A100J	CHIP R 10 J 1/10W		D49			IMSA-6801	SURGE ABSORBER	
R210			RK73EB2E101J	CHIP R 100 J 1/4W		D50-56			DA204K	DIODE	
R211,212			RK73EB2E472J	CHIP R 4.7K J 1/4W		D50-56			KDS226	DIODE	K1K2M1
R213			RK73EB2E4R7J	CHIP R 4.7 J 1/4W		D60,61			DA204U	DIODE	
R214			RK73EB2E472J	CHIP R 4.7K J 1/4W		IC1		*	UPD703033GFA03	MI-COM IC	K2M1E
R215			RK73EB2E100J	CHIP R 10 J 1/4W		IC1		*	UPD703033GFA04	MI-COM IC	K1
R216,217			RK73EB2E472J	CHIP R 4.7K J 1/4W		IC2			TDA7407	ANALOGUE IC	
R218			RK73EB2E101J	CHIP R 100 J 1/4W		IC3			M5237ML	IC(VOLTAGE REGULATOR)	
R219			RK73EB2E100J	CHIP R 10 J 1/4W		IC4			TDA7560	ANALOGUE IC	
R220			RK73EB2E101J	CHIP R 100 J 1/4W		IC5			TDA7401	ANALOGUE IC	
R221			RK73FB2B102J	CHIP R 1.0K J 1/8W		IC6		*	SI-8033JD	ANALOGUE IC	K2M1E
R222			RK73GB2A223J	CHIP R 22K J 1/10W		IC7			ICL7660SIBA	ANALOGUE IC	
R223			RK73FB2B102J	CHIP R 1.0K J 1/8W		IC8			S-80837ANNP	MOS-IC	
R224			RK73GB2A223J	CHIP R 22K J 1/10W		IC9			HD74HC02FP	MOS-IC	K1K2M1
R226			RK73GB2A472J	CHIP R 4.7K J 1/10W	M1E	IC9			TC74HC02AF	MOS-IC	
R227-233			RK73GB2A222J	CHIP R 2.2K J 1/10W	M1E	IC10-13			NJM4565M-TE2	ANALOGUE IC	
R230-232			RK73GB2A222J	CHIP R 2.2K J 1/10W	K1K2	IC14			SAA6581T	ANALOGUE IC	M1E
R240			RK73GB2A472J	CHIP R 4.7K J 1/10W		IC15			LB1930M	ANALOGUE IC	
R241			RK73GB2A223J	CHIP R 22K J 1/10W							

E : KDC-PSW9521

M1 : KDC-9020R

K1 : KDC-X759

K2 : KDC-MP919

E: Europe K: North America M: Other Areas

W: Without Europe

 indicates safety critical components.

KDC-9020R/MP919/PSW9521/X759

PARTS LIST

* New Parts

Parts without **Parts No.** are not supplied.

Les articles non mentionnés dans le **Parts No.** ne sont pas fournis.

Teile ohne **Parts No.** werden nicht geliefert.

ELECTRIC UNIT (X25-91xx-xx)

Ref.No.	A d d	N e w	Parts No.	Description	Dest inati on	Ref.No.	A d d	N e w	Parts No.	Description	Dest inati on
Q1			KTA1046	TRANSISTOR		Q50			2SB1427	TRANSISTOR	
Q2			2SC4081	TRANSISTOR		TH1			PTH9C42BD471Q	POSITIVE RESISTOR	
Q3			2SA1576A	TRANSISTOR		A1		*	W02-3340-05	ELECTRIC CIRCUIT MODULE	
Q4			DTA124EUA	DIGITAL TRANSISTOR		A2			X86-3240-11	TUNER UNIT	K1K2
Q4			KRA303	DIGITAL TRANSISTOR	K1K2M1	A2			X86-3242-70	TUNER UNIT	M1
Q5			DTC124EUA	DIGITAL TRANSISTOR		A2			X86-3342-71	TUNER UNIT	E
Q5		*	KRC403	DIGITAL TRANSISTOR	K1K2M1						
Q6			DTC144EUA	DIGITAL TRANSISTOR							
Q6		*	KRC404	DIGITAL TRANSISTOR	K1K2M1						
Q7			DTA124EUA	DIGITAL TRANSISTOR							
Q7			KRA303	DIGITAL TRANSISTOR	K1K2M1						
Q8			KTA1046	TRANSISTOR							
Q9			2SD2375	TRANSISTOR							
Q10			2SC4081	TRANSISTOR	K2M1E						
Q11			DTC124EUA	DIGITAL TRANSISTOR							
Q11		*	KRC403	DIGITAL TRANSISTOR	K1K2M1						
Q12			DTA124EUA	DIGITAL TRANSISTOR							
Q12			KRA303	DIGITAL TRANSISTOR	K1K2M1						
Q13			KTA1046	TRANSISTOR							
Q14			2SC4081	TRANSISTOR							
Q15			2SB1443	TRANSISTOR							
Q16 ,17			2SC4081	TRANSISTOR							
Q18 ,19			2SA1576A	TRANSISTOR							
Q20			2SC4081	TRANSISTOR							
Q21			2SA1576A	TRANSISTOR							
Q22			2SC4081	TRANSISTOR							
Q23		*	DTC114YUA	DIGITAL TRANSISTOR	K1K2						
Q23			KRC407	DIGITAL TRANSISTOR	K1K2						
Q24 ,25			2SB1277(Q,R)	TRANSISTOR	K1K2						
Q25			2SB1277(Q,R)	TRANSISTOR	M1E						
Q26			2SA1576A	TRANSISTOR							
Q27			DTA124EUA	DIGITAL TRANSISTOR							
Q27			KRA303	DIGITAL TRANSISTOR	K1K2M1						
Q28			DTC114YUA	DIGITAL TRANSISTOR							
Q28		*	KRC407	DIGITAL TRANSISTOR	K1K2M1						
Q29			DTA123JK	DIGITAL TRANSISTOR	K1M1E						
Q29			KRA105S	DIGITAL TRANSISTOR	K1M1						
Q30			DTC144EUA	DIGITAL TRANSISTOR							
Q30		*	KRC404	DIGITAL TRANSISTOR	K1K2M1						
Q31 ,32			2SC4081	TRANSISTOR							
Q33 ,34			DTA124EUA	DIGITAL TRANSISTOR							
Q33 ,34			KRA303	DIGITAL TRANSISTOR	K1K2M1						
Q35			2SC4081	TRANSISTOR							
Q36			DTC124EUA	DIGITAL TRANSISTOR							
Q36		*	KRC403	DIGITAL TRANSISTOR	K1K2M1						
Q37 -43			DTC143TUA	DIGITAL TRANSISTOR							
Q37 -43			KRC410	DIGITAL TRANSISTOR	K1K2M1						
Q45			DTC124EUA	DIGITAL TRANSISTOR							
Q45		*	KRC403	DIGITAL TRANSISTOR	K1K2M1						
Q46			2SB1188(Q,R)	TRANSISTOR							
Q47			DTC124EUA	DIGITAL TRANSISTOR							
Q47		*	KRC403	DIGITAL TRANSISTOR	K1K2M1						
Q48			2SB1188(Q,R)	TRANSISTOR							
Q49			DTC143TUA	DIGITAL TRANSISTOR	M1E						
Q49			KRC410	DIGITAL TRANSISTOR	M1						

E : KDC-PSW9521

M1 : KDC-9020R

K1 : KDC-X759

K2 : KDC-MP919

E: Europe K: North America M: Other Areas

W: Without Europe

 indicates safety critical components.

KDC-9020R/MP919/PSW9521/X759

SPECIFICATIONS

		KDC-9020R
FM	Frequency Range (Frequency step)	87.5MHz - 108.0MHz(50kHz)
	Channel Space Selection	50kHz
	Usable Sensitivity S/N:30dB	9.3dBf (0.8 μ v/75 Ω)
	Quieting Sensitivity S/N 50dB	15.2dBf (1.6 μ v/75 Ω)
	Frequency Response (\pm 3.0dB)	30Hz-15kHz
	S/N(dB)	70dB(MONO)
	Selectivity	\geq 80dB(\pm 400kHz)
	Stereo Separation	40dB(1kHz)
MW (AM)	Frequency Range(KHz) (Frequency step)	531kHz-1611kHz (9kHz)
	Usable Sensitivity (S/N 20dB)	25 μ v
LW	Frequency Range(KHz)	153kHz-281kHz
	Usable Sensitivity (S/N 20dB)	45 μ v
CD	Laser Diode	GaAlAs(λ =780nm)
	Digital Filter(D/A)	8 Times OverSampling
	D/A Converter	1 Bit
	Spindle Speed	1000~400(CLV • 2times)
	Wow & Flutter	Below Mesurable Limit
	Frequency Response	10-20kHz(\pm 1dB)
	Total Harmonic Distortion	0.01%(1kHz)
	S/N Ratio (dB)	105dB(1kHz)
	Dynamic Range	93dB
	Channel Separation	95dB
	MP3 decord	MPEG1.0 Audio Layer3
WMA decord	Windows Media Audio7	
Preout Level(mV)/Load -Unbalanced		4500mV/10k Ω (CD/CD-CH)
Preout Impedance(Ω)		80 Ω
AMP	Maximum Power	50wx4
	Full Bandwidth Power (at less than 1%THD)	22wx4
TONE	Bass	100Hz \pm 10dB
	Middle	1kHz \pm 10dB
	Treble	10kHz \pm 10dB
GENE	Operating voltage (11~16v allowable)	14.4v
	Current Consumption	10A
	Installation Size (W) (H) (D)	182(mm) 53(mm) 162(mm)
	Weight	1.5kg

KDC-9020R/MP919/PSW9521/X759

SPECIFICATIONS

		KDC-X759	KDC-MP919
FM	Frequency Range (Frequency step)	87.9MHz - 107.9MHz (200kHz)	87.9MHz - 107.9MHz (200kHz)
	Channel Space Selection	50k/200kHz	50k/200kHz
	Usable Sensitivity S/N:30dB	9.3dBf (0.8 μ V/75 Ω)	9.3dBf (0.8 μ V/75 Ω)
	Quieting Sensitivity S/N 50dB	15.2dBf (1.6 μ V/75 Ω)	15.2dBf (1.6 μ V/75 Ω)
	Frequency Response (\pm 3.0dB)	30Hz-15kHz	30Hz-15kHz
	S/N	70dB(MONO)	70dB(MONO)
	Selectivity	\geq 80dB (\pm 400kHz)	\geq 80dB (\pm 400kHz)
	Stereo Separation	40dB(1kHz)	40dB(1kHz)
AM	Frequency Range (Frequency step)	530kHz - 1700kHz (10kHz)	530kHz - 1700kHz (10kHz)
	Channel Space Selection	9k/10kHz	9k/10kHz
	Usable Sensitivity S/N:20dB	28dB μ (25 μ v)	28dB μ (25 μ v)
CD	Laser Diode	GaAlAs(λ =780nm)	GaAlAs(λ =780nm)
	Digital Filter(D/A)	8 Times OverSampling	8 Times OverSampling
	D/A Converter	1 Bit	1 Bit
	Spindle Speed	500~200(CLV)	1000~400(CLV • 2times)
	Wow & Flutter	Below Mesurable Limit	Below Mesurable Limit
	Frequency Response	10-20kHz(\pm 1dB)	10-20kHz(\pm 1dB)
	Total Harmonic Distortion	0.01%(1kHz)	0.01%(1kHz)
	S/N Ratio (dB)	105dB(1kHz)	105dB(1kHz)
	Dynamic Range	93dB	93dB
	Channel Separation	95dB	95dB
	MP3 decord		MPEG1.0 Audio Layer3
	WMA decord		
Preout Level(mV)/Load -Unbalanced		4500mV/10k Ω (CD/CD-CH)	4500mV/10k Ω (CD/CD-CH)
Preout Impedance(Ω)		80 Ω	80 Ω
AMP	Maximum Power	50wx4	50wx4
	Full Bandwidth Power (at less than 1%THD)	22wx4	22wx4
TONE	Bass	100Hz \pm 10dB	100Hz \pm 10dB
	Middle	1kHz \pm 10dB	1kHz \pm 10dB
	Treble	10kHz \pm 10dB	10kHz \pm 10dB
GENE	Operating voltage (11~16v allowable)	14.4v	14.4v
	Current Consumption	10A	10A
	Installation Size (W)	182(mm) 7-3/16(in)	182(mm) 7-3/16(in)
	(H)	53(mm) 2-1/16(in)	53(mm) 2-1/16(in)
	(D)	162(mm) 6-3/8 (in)	162(mm) 6-3/8 (in)
Weight		3.3 lbs(1.5kg)	3.3 lbs(1.5kg)

KDC-9020R/MP919/PSW9521/X759

SPECIFICATIONS

		KDC-PSW9521
FM	Frequency Range(MHz) (Frequency step)	87.5MHz-108.0MHz (50kHz)
	Usable Sensitivity (S/N 26dB)	0.7 μ v/75 Ω
	Quieting Sensitivity (S/N 46dB)	1.6 μ v/75 Ω
	Frequency Response (\pm 3.0dB)	30Hz-15kHz
	S/N(dB)	65dB(MONO)
	Selectivity(DIN)(dB)	\geq 80dB(\pm 400kHz)
	Stereo Separation	35dB(1kHz)
MW (AM)	Frequency Range(KHz) (Frequency step)	531kHz-1611kHz (9kHz)
	Usable Sensitivity (S/N 20dB)	25 μ v
LW	Frequency Range(KHz)	153kHz-281kHz
	Usable Sensitivity (S/N 20dB)	45 μ v
CD	Laser Diode	GaAlAs(λ =780nm)
	Digital Filter(D/A)	8 Times OverSampling
	D/A Converter	1 Bit
	Spindle Speed	1000~400(CLV • 2times)
	Wow & Flutter	Below Mesurable Limit
	Frequency Response	10-20kHz(\pm 1dB)
	Total Harmonic Distortion	0.01%(1kHz)
	S/N Ratio (dB)	105dB(1kHz)
	Dynamic Range	93dB
	Channel Separation	95dB
	MP3 decord	MPEG1.0 Audio Layer3
WMA decord	Windows Media Audio7	
Preout Level(mV)/Load -Unbalanced		1800mV/10k Ω (CD/CD-CH)
Preout Impedance(Ω)		80 Ω
AMP	PWR(MAX)	50wx4
	PWR DIN45324,+B=14.4V	30wx4
TONE	Bass	100Hz \pm 10dB
	Middle	1kHz \pm 10dB
	Treble	10kHz \pm 10dB
GENE	Operating voltage (11~16v allowable)	14.4v
	Current Consumption	10A
	Installation Size (W)	182(mm)
	(H)	53(mm)
	(D)	162(mm)
Weight		1.5Kg

KENWOOD follows a policy of continuous advancements in development. For this reason specifications may be changed without notice.

KENWOOD CORPORATION

14-6, Dogenzaka 1-chome, Shibuya-ku, Tokyo, 150-8501 Japan

KENWOOD SERVICE CORPORATION

P.O. Box 22745, 2201 East Dominguez Street,
Long Beach, CA90801-5745, U.S.A.

KENWOOD ELECTRONICS CANADA INC.

6070 Kestrel Road, Mississauga, Ontario, Canada L5T 1S8

KENWOOD ELECTRONICS LATIN AMERICA S.A.

P.O. Box 55-2791 Paitilla, Plaza Credicorp Bank Panama,
Piso 9, Oficina 901, Calle 50, Panama, Republic of Panama

KENWOOD ELECTRONICS BRASIL LTDA.

Alameda Ministro Rocha Azevedo No. 456,
Edifício Jaú, 10o Andar, Cerqueira César, Cep 0140-001,
São Paulo-SP-Brasil

KENWOOD ELECTRONICS UK LIMITED

Kenwood House, Dwight Road, Watford,
Herts, WD1 8EB, United Kingdom

KENWOOD ELECTRONICS DEUTSCHLAND GMBH

Rembrücker Str. 15, 63150 Heusenstamm, Germany

KENWOOD ELECTRONICS FRANCE S.A.

13, Boulevard Ney, 75018 Paris, France

KENWOOD ELECTRONICS BELGIUM N.V.

Leuvensesteenweg 248 J, 1800 Vilvoorde, Belgium

KENWOOD ELECTRONICS ITALIA S.p.A.

Via G. Sirtori 7/9, 20129 Milano, Italy

KENWOOD IBÉRICA S.A.

Bolivia, 239-08020 Barcelona, Spain

KENWOOD ELECTRONICS AUSTRALIA PTY. LTD.

(A.C.N. 001 499 074)
16 Giffnock Avenue, Centrecourt Estate, North Ryde,
N.S.W. 2113, Australia

KENWOOD ELECTRONICS (HONG KONG) LTD.

Unit 3712-3724, Level 37, Tower 1, Metroplaza,
223 Hing Fong Road, Kwai Fong, N.T., Hong Kong

KENWOOD ELECTRONICS GULF FZE

P.O.Box 61318, Jebel Ali, Dubai, U.A.E.

KENWOOD ELECTRONICS (THAILAND) CO., LTD.

2019 New Pechburi Road, Bangkok, Huaykwang,
Bangkok, 10320 Thailand

KENWOOD ELECTRONICS SINGAPORE PTE LTD.

1 Genting Lane, #07-00, Kenwood Building, Singapore 349544

KENWOOD ELECTRONICS (MALAYSIA) SDN BHD

#4.01 Level 4, Wisma Academy Lot 4A, Jalan 19/1,
46300 Petaling Jaya, Selangor Darul Ehsan, Malaysia